



# Measuring Static Overpressures in Air Blast Environments

Patrick L. Walter, Ph. D.

Senior Measurement Specialist, PCB Piezotronics, Inc.  
Depew, NY 14043

Professor of Engineering, Texas Christian University  
Fort Worth, TX 76129

The damage potential of a blast wave is dependent upon both the force it exerts on an object and the duration over which the force is applied. An assessment of this damage potential requires measurement of: (1) the peak static overpressure and (2) the total impulse per unit area of the blast wave. The static overpressure is the transient differential pressure in the air blast relative to the ambient pressure value just before arrival of the pressure shock. Colloquial terms for static overpressure include incident, free-field, and side-on pressure. Accurate measurement of the static overpressure in an air blast is extremely challenging. Pressure rise times can be sub-microsecond, demanding extremely high-frequency response from the measuring pressure transducers and their associated signal conditioning. In addition, concurrent transient temperatures in the 1000s of degrees F or C, ground shocks and their associated strain waves, intense light, fragment impact, ionized gases, and other undesired environments all attempt to couple into the transducer and its mount, the instrumentation cabling, and other measurement system components. If the influence of these undesired environments is not compensated for or isolated, the signal output from the measurement system can be severely corrupted. The work presented here attempts to review, enhance, and add to lessons learned over the years in attempting static overpressure measurements. Its goal is to increase the probability of success for the test engineer or technician responsible for acquiring these measurements.

## Introduction

An explosion is a phenomenon that results from a rapid release of energy. One cause can be unstable chemical compounds rapidly transforming themselves at a site to a more stable form with a resultant release of energy. This energy transformation results in gas formation (pressure) and intense heat. While chemical explosions are the most

common, it should be noted that flour dust, pressurized steam, gas bottles, spark gaps, etc. can also be explosive sources. The focal point of this paper will be to bring together in one place the guidance necessary to field pressure transducers that will acquire valid measurements of the static overpressure associated with an explosion.

The static overpressure is the transient differential pressure in the air blast relative to the ambient pressure just before arrival of the shock wave. If  $p_1$  is the ambient pressure before the blast wave arrives at a point and  $p_2$  is the absolute pressure in the blast wave at this point, the static overpressure  $\Delta p$  is:

$$\Delta p = p_2 - p_1, \quad (1)$$

where  $\Delta p$  varies in a non-linear fashion as the blast wave passes.

The damage potential of a blast wave is associated with both the force it exerts on an object and the duration over which the force is applied. This assessment requires measurement of: (1) the peak static overpressure and (2) the total impulse (integral of the static overpressure versus time) results in an exchange of momentum between the explosive source and any structure which encounters the blast wave. Because the quarter wavelength of the natural frequency of most

structures is longer than the duration of the blast wave, structures are usually more sensitive to the effects of total impulse than to peak pressure.

In the 1950s and 1960s, driven in part by atmospheric nuclear testing, developmental work was performed in both U. S. laboratories (primarily the Army's Ballistics Research Laboratory) and British laboratories to develop blast pressure transducers to measure static overpressure. Much of this research was focused on: (1) "pencil" probes (or gages) and (2) "pancake" or "lolly-pop" gages. Both types were designed to measure at locations above ground level. The latter gage, shown in Fig. 1, has

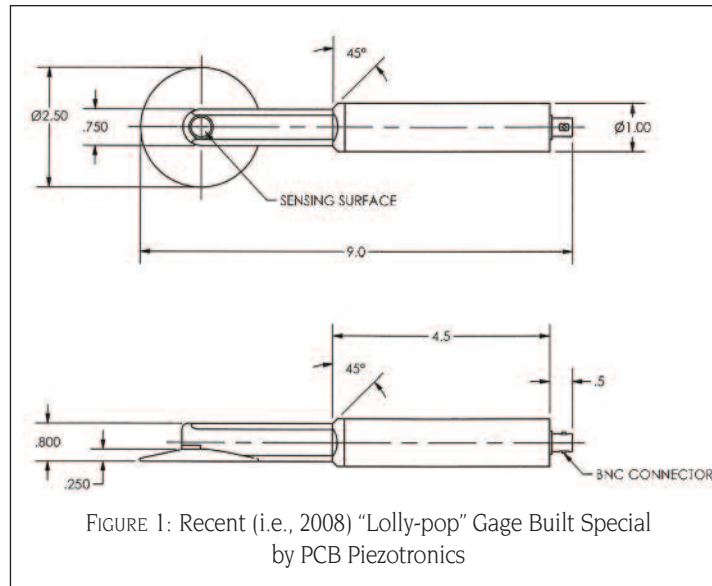

FIGURE 1: Recent (i.e., 2008) "Lolly-pop" Gage Built Special by PCB Piezotronics



largely disappeared from use due to the greater difficulty in accurately aligning it with the explosive source. Its principal virtue is that it will accurately measure ground reflections arriving essentially parallel to its sensing face. As an alternative to above ground level approaches, static overpressure can also be measured at ground level with transducers whose sensing face is in the horizontal plane of the ground surface.

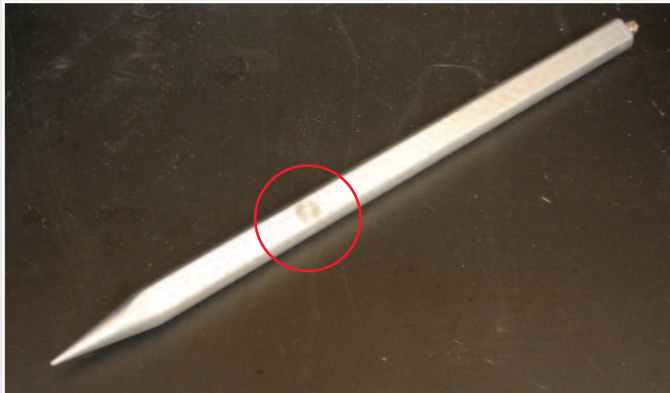

FIGURE 2: PCB 137 Pencil Probe 1

The definitive history of the development of the “pencil” probe / gage appears to be lost, although early R&D reports on the “lolly-pop” gage are still retrievable [1]. In 1976, a Defense Nuclear Agency study on technology for measuring air blast phenomena [2] documented best measurement practices. References to both “lolly-pop” and “pencil” probes are included.

The remainder of this document will describe transducer related considerations associated with making both above ground (“pencil” probe) and ground-level measurements of static overpressure. As noted, these are the two most common methods used today. Further discussion topics, including data interpretation, will also be provided. While interest in measuring static overpressure has never disappeared, the first decade of the 21st century has certainly rekindled it.

## MEASUREMENT TRANSDUCER TYPES

Figure 2 is a photograph of the pencil probe. It is 16” long from its tip to the base of its connector and 0.85” in diameter. A blast wave normally incident to the longitudinal axis of the probe will become distorted at its higher frequencies (shorter wavelengths) when encountering the probe tip. However, the wave will reconstitute itself by the time it arrives at the sensing face, which is located transverse to the longitudinal axis of the probe (circled in red in Fig. 2). A machined “flat” along the side of the probe minimizes distortion of the blast wave that would otherwise occur due to the flat sensing face of the sensor protruding from a cylindrical probe body. When the probe is pointed at an incident, planar blast wave, the configuration portrayed permits accurate measurement of its static overpressure.

As noted previously, the pencil probe was developed at the Ballistics Research Laboratory (BRL). Its technology was strongly influenced by a

BRL employee in the late 1950s and early 1960s who subsequently set up his own company (Susquehanna Instruments/Ben Granath). At Susquehanna the probe was commercially designated the model ST-7. In 1982, Susquehanna Instruments became integrated into PCB Piezotronics. The probe remains today as it became a PCB product with two significant exceptions: (1) the probe material was changed from ceramic to quartz and (2) ICP® electronics [3] were integrated into the probe enabling five volts full scale output for each of its various pressure ranges (50 to 1,000 psi maximum). The current PCB probe model number is 137. The resonant frequency of its sensor is >500 KHz. Figure 3 shows the pencil probe on the end of a longitudinal rod on a support stand, representing one configuration for field mounting. Probe mounting will be discussed further in a later section of this work.



FIGURE 3: Pencil Probe Field Application

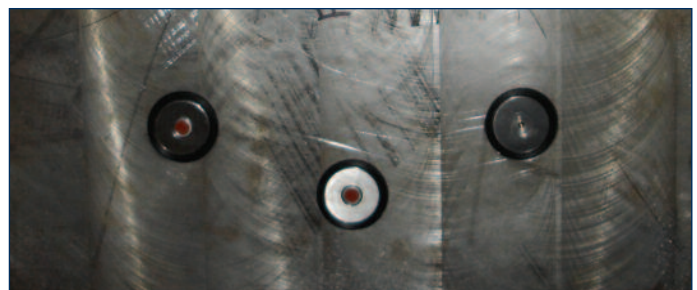

FIGURE 4: Various Ground Mounted Transducers

Ground-surface transducers use either quartz type or piezoresistive (synonym PR or Micro Electro Mechanical Systems (MEMS)) type sensing technologies. Each of these technologies is different and requires different signal conditioning. Quartz transducers operate physically on the principle that a compressive force on a material with no center of charge symmetry generates a resultant charge output. These transducers, similar to the model 137, typically have internal Integrated Circuit Piezoelectric (ICP®) circuitry and use the same type ICP® signal conditioning as the 137 to provide a 5 volt full scale output signal.



MEMS based transducers are typically manufactured from bulk silicon through chemical etching. Impurities are subsequently doped into the silicon at predetermined locations, creating resistive elements. These resistors are metalized and configured into a Wheatstone bridge. The bridge requires a regulated power supply and a differential amplifier to operate successfully. In some instances multi-layered silicon-on-insulator (SOI) material is used in fabrication enabling more sophisticated designs. All MEMS pressure transducers typically have full-scale outputs of 100 to 200 mV, resonant frequencies of 200 KHz to 1,000 KHz, and are available from numerous suppliers. Figure 4 shows three ground-mounted transducers and Fig. 5 illustrates that if applied properly both quartz and MEMS technologies provide reasonable correlation when responding to a blast wave.

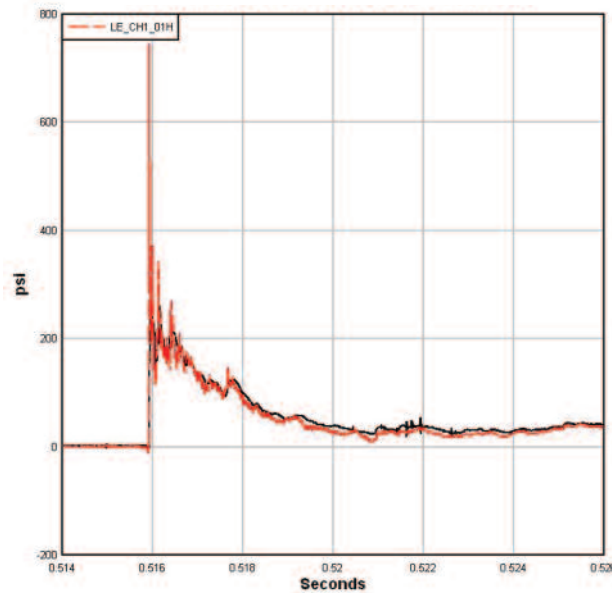

FIGURE 5: Quartz (red) and MEMS (black) Ground Probes Correlating on Ground Overpressure Measurements

## MOUNTING CONSIDERATIONS

Of the two techniques described, pencil probe and ground surface, the ground surface measurement has the greater potential to be adversely influenced by: (1) varying surface conditions, (2) reflected air shocks, and (3) ground-induced shocks. However, if the ground surface is smooth and level, and proper mounting techniques are used, as shown, good correlation between pencil probe and ground mounted transducers can be achieved. Both will be discussed in the following paragraphs.

### Pencil Probe:

#### Orientation

Figure 6 originates from work performed by Pete Silver & Scott Walton at Aberdeen Proving Grounds [4]. The center curve shows that if the pencil probe is maintained within  $\pm 5$  degrees of normal to the incident blast wave, the error in peak pressure measured due to probe misalignment is less than five percent. Therefore, if the pencil probe is properly aligned, and if other error sources are temporarily ignored, this percentage error will be maintained until ground or other off-angle reflected shocks arrive at the probe.

For a traveling wave, the relationship between wavelength ( $\lambda$ ), frequency ( $f$ ), and wave velocity ( $c$ ) is:

$$\lambda f = c \quad (2)$$

From Eq. (2) it is apparent that as  $f$  increases, and thus as  $\lambda$  becomes smaller, the probe will increasingly appear as a reflecting body to the blast components of smaller wavelengths approaching from directions other than normal to the longitudinal axis of the probe body (shown in Figure 2). Figure 7 shows this critical alignment being performed.

In the case of explosions close to but not on the surface of the ground, the downward moving portion of the blast wave reflects from the ground surface. This reflected shock intersects the remainder of the still incoming shock at the "triple point" forming a Mach stem below which the shock front moves radially outward becoming progressively more perpendicular to the ground surface [5]. It is typically desired to acquire measurements in this Mach stem, which grows in height as it moves outward. Measurements taken before the Mach stem forms are complicated to analyze due to: (1) a lack of symmetry close in to the explosive source and (2) both incident and reflected shock waves.

For an explosion occurring at ground level on a perfectly rigid surface, an explosive yield calculation based on measured values would be divided by two in order to translate it into an equivalent air-burst yield. For real surfaces such as concrete, clay, or sand, this calculation typically requires a divisor between 1.7 and 2.0.

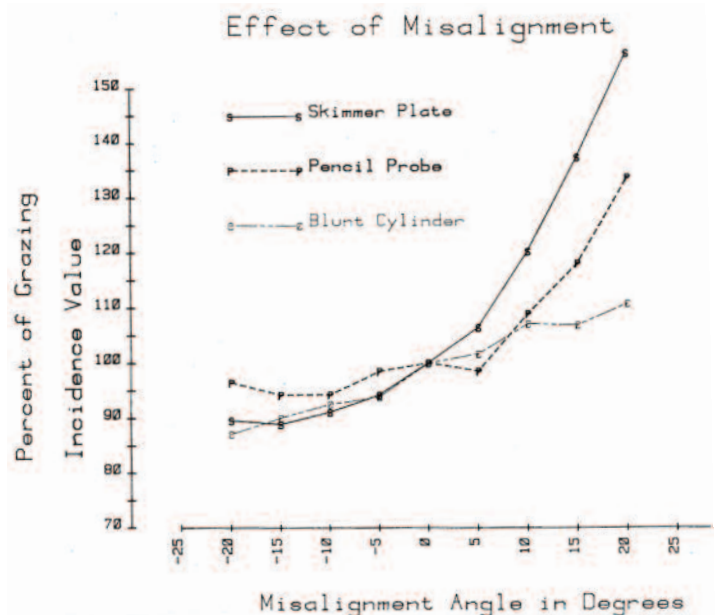

FIGURE 6: Error Magnitude Due to Pencil Probe Misalignment (Center Above)



## Other Considerations

In pencil probe applications, both mechanical and electrical isolation should be provided. The pencil probe is typically mechanically adapted to an electrically conductive test stand or holder by a nonconductive material (e.g., nylon, Teflon®, Delrin®). This adaptation provides electrical isolation between the probe's case (i.e., the probe's signal reference) and the path for any electrical grounding through the stand. This electrical isolation enables only a single electrical ground reference to exist, which should be satisfied within any instrumentation channel.

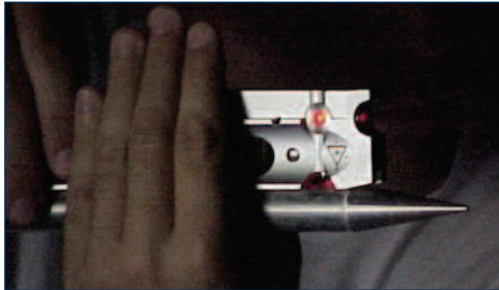

FIGURE 7: Probe Alignment

On surfaces such as concrete floors, a mechanical ground shock will propagate through the floor ahead of the air blast wave and will couple into the probe stand. The effect of this ground shock on the mounted pencil probe is typically small as far as disturbing the measurement. However, Fig. 8 below shows low-density foam placed under the stand's corners to block this transmission path if necessary.

Associated with the air blast wave resulting from the explosion are transient temperatures greater than 3000 degrees F. These temperatures are attributable to the compressed gaseous products traveling ahead of the fireball. The heat transfer mechanism is a combination of radiation and convection with radiation being dominant. Analysis has shown [6] that for blast pressure exposures of less than 25 msec. the face of a sensing transducer should experience a temperature rise of no more than 5-15 degrees F.

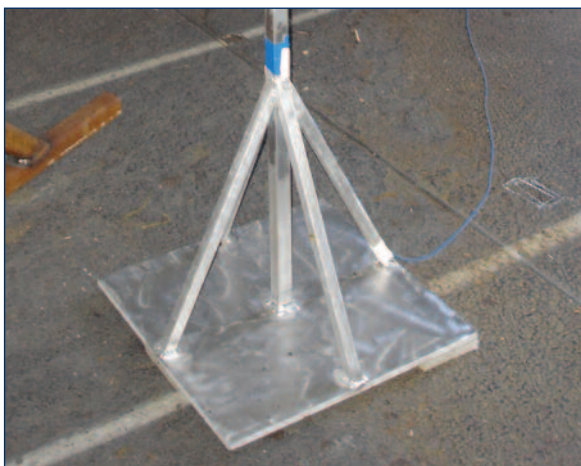

FIGURE 8: Mechanically Isolated Test Stand

For quartz-based transducers this transient thermal exposure can result in a false negative pressure drift indication, which is due to a thermal expansion occurring in the internal housing of the transducer containing the preloaded quartz sensing assembly. The expansion results in a slight release of the preload on the stacked quartz elements.



FIGURE 9: Wrap of Tape around Probe Sensing Face

The false indication can usually be greatly lessened by closely matching the thermal expansion coefficients of probe construction materials (e.g., quartz and invar). However, even if thermal expansion coefficients are closely matched, thermal diffusivity properties between materials differ. That is, some materials may more rapidly adjust their temperature to that of their surroundings, because they conduct heat quickly in comparison to their volumetric heat capacity or “thermal bulk”. If thermal transient response of the probe still remains a concern, a tight wrap of black electrical tape around the sensor (as in Fig. 9) can further delay any heat transfer into the sensing face of the probe until the blast wave passage is complete.

## **Ground Surface Mounted Sensors**

### Orientation

Transducers mounted in the plane of the ground surface can use either quartz or MEMS technologies as their sensing methodologies. As shown in Fig. 4, the sensing face of the transducer(s) must be flush with the surface of a plate in which they are mounted. The top surface of this plate must in turn be flush with the ground surface. If the transducer should protrude from the plate, the protrusion will introduce errors by partially reflecting the blast wave. Alternately, if the transducer is recessed in the plate, the resultant acoustic cavity [7] can act as a resonator. Oscillations caused by this cavity can be large (Fig. 10 [4]) resulting in an erroneous portrayal of the blast wave.

Once again the transducer should be located in the mach stem so that it encounters only the static overpressure passing across the transducer's sensing surface. The ground surface should be free of rocks and, as noted previously, level with the mounting plate for the transducer. The plate size required is somewhat dictated by ground surface conditions. A 4-foot square plate should be adequate. If the ground shock is particularly severe (e.g., measurement is being made close to a large explosive quantity), a concrete pad might be poured to mitigate the shock (Fig. 11).

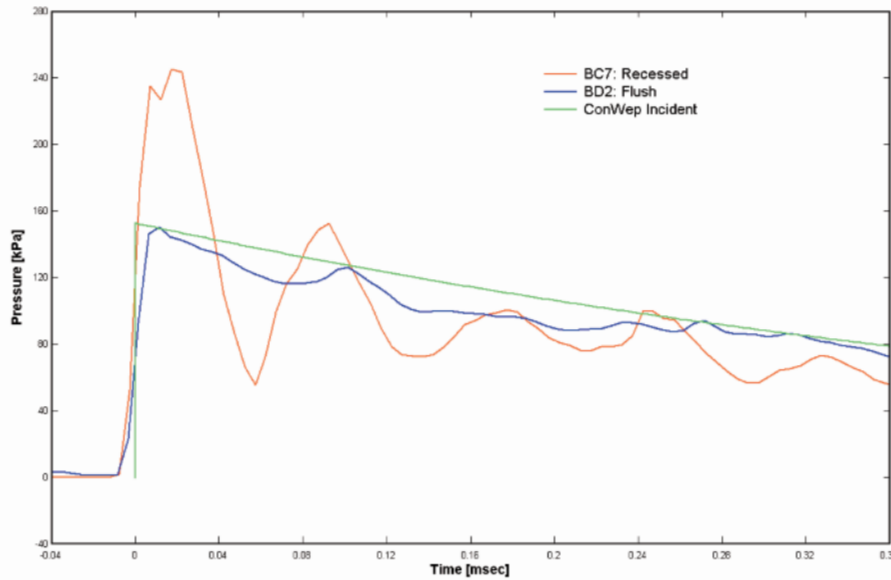

FIGURE 10:  
Cavity Oscillations (red),  
Flush Mount (blue),  
and Predicted Response (green)

## Other Considerations

The upper left portion of Fig. 11 shows the ground surface transducer mounted in a Teflon® bushing. Some confusion exists over the difference between strain and acceleration sensitivity when specifying blast transducers. Usually the pressure transducer is mounted in a large, low-frequency plate so that it experiences very little acceleration. However, the transducer does encounter large transient strain waves induced in these plates.

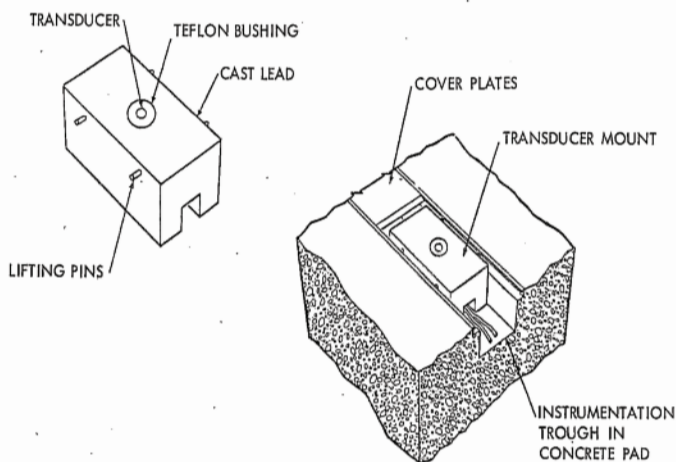

FIGURE 11: Transducer Mount in Concrete Pad

Ideally the quartz and MEMS transducers would respond only to pressure induced strain on their sensing faces. In actuality they respond to strain induced by any source. It is then required to impedance mismatch the transducer from the steel mounting plate so that transient strains do not couple into its signal. Materials such as Teflon®, Delrin, and nylon accomplish this goal. See Figure 12.

As with the pencil probe, radiant and convective heat transfer can create false pressure signals. For the quartz ground-sensors a ceramic or RTV rubber coating is placed on their sensing face to provide a thermal delay until the blast wave has passed. For MEMS sensors of the bulk-silicon type, a protective or “shadowing” screen is typically placed over the



FIGURE 12: Delrin Adapter

sensing face, and opaque grease is placed behind the screen on this sensing face. The purpose of the opaque grease is to block error signals due to light (photovoltaic effect), and the screen is a barrier to both radiant and convective heat transfer. The grease also provides a thermal delay against resistance changes (photoresistive effect). If MEMS silicon-on-insulator (SOI) technology is used, the light sensitivity effects can be eliminated in sensor design. SOI technology does not eliminate the false, thermally-induced pressure signals, which can be positive or negative in polarity.

## FIELDING ASSISTANCE

Transducer placement is dependent on the configuration and quantity of the explosive test item, on other items present in the test arena (e.g., witness plates), on the height of the test item at detonation, on preparation of the ground surface, and more. As noted previously, it is desired to have the sensors located in the mach stem looking into a planar shock front. This enables the easiest data interpretation. If sensors are positioned ahead of the mach stem formation, all pencil probes should point at the explosive source and their resultant signals should be analyzed as an air-burst. Subsequent ground reflections would create ambiguities for both pencil probes and ground surface transducers at these close-in locations. The sensor array should be



planned to acquire statistics by varying distances and azimuths between sensor locations. Pencil probe stands should not “shadow” or interfere with each other when placed in a row. Shadowing can be avoided by proper incrementing of sensor height and/or relative displacement between each. Figure 13 shows one example of transducer placement for a specific arena event.

Fragments from caged explosives can collide with transducers and even damage them. In addition, these fragments can have their own local shock waves traveling with them creating a certain amount of confusion in the interpretation of data. Fragmentation poles can be placed in front of a row of sensors along a radius to deflect these fragments. For caged explosives where significant fragments are expected, these poles are recommended. If fragmentation poles were required for the test in Fig. 13, they would precede each row of transducers (gages).

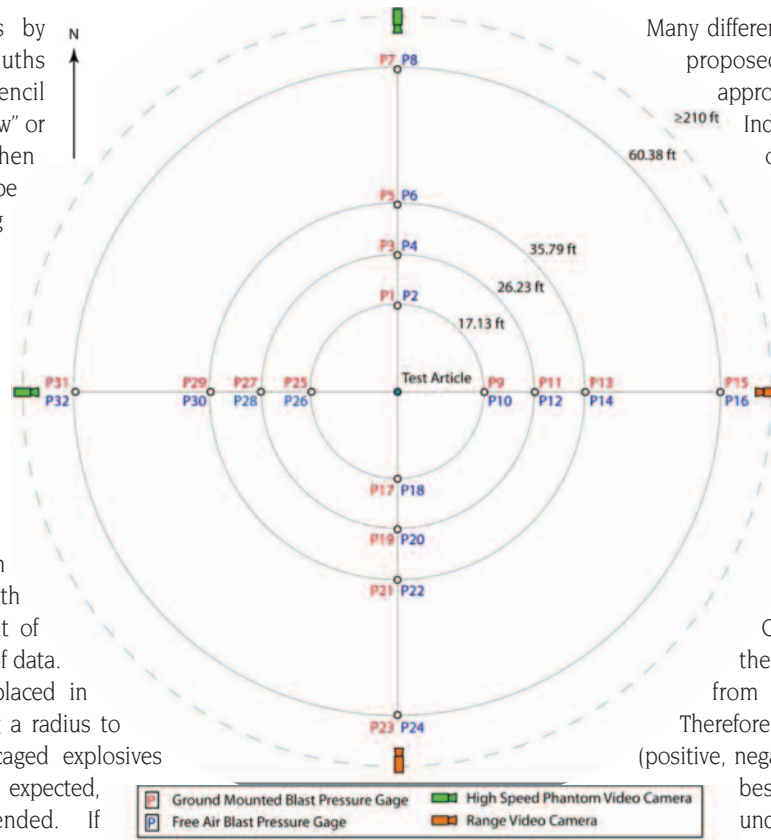

FIGURE 13: One Example of a Blast Pressure Array

Many different fits to a blast wave have been proposed [8], but its basic form approximates a decaying exponential. Individual judgment must be applied on the part of the experimenter as to the initial portion of the recorded data over which this fit is justified. Figure 14 shows such a fit and the intersection of the value of the exponential fit (in red) at time  $t = 0$  defines the value for the peak pressure. This value will typically be combined with other results at equivalent radii to generate a statistic for this distance.

Over the blast pressure duration, the exponential fit tends to deviate from the ideal for many reasons. Therefore, when calculating total impulse (positive, negative, or both) per unit area, it is best to integrate the actual area under the pressure-time curve. Any error due to overshoot at  $t = 0$  will be very small in the resultant calculation.

## DATA ANALYSIS

If one were to expand the initial portion of Fig. 5 to display the rise times, two observations could be made. The high, initial transient spike is associated with the pencil probe and is due to the transient response of the quartz sensing element in the transducer. The shock front passing the sensing surface of the transducer contains frequency content high enough to excite the structural resonance of the housed quartz transduction element causing overshoot due to resonant excitation. By contrast, the second transducer (MEMS) undershoots the peak pressure because the screen covering its sensing surface limits its rise time so that the resonance of its silicon flexure is not excited. If it were not for the screen, it would also overshoot. Since it was earlier stated that an assessment of the damage potential of a blast wave depends on (1) the peak static overpressure and (2) the total impulse per unit area of the blast wave, a method to approximate the “true” peak pressure of the recorded waveform must be provided. One method to make this assessment is described in the next paragraph.

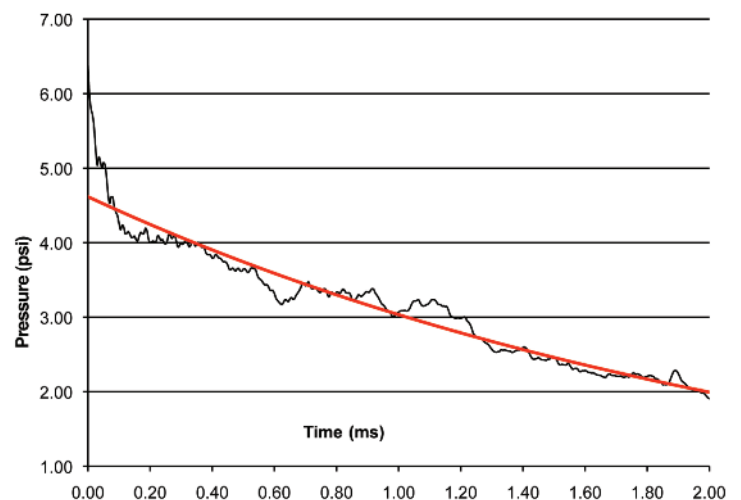

FIGURE 14: Fit of an Exponential to a Blast Wave for Determination of the Peak Value



## SIGNAL TRANSMISSION AND RECORDING CONSIDERATIONS

The preceding discussion has focused on transducer type, mounting requirements, mechanical and thermal isolation, and placement for static overpressure readings. Discussion has also occurred regarding data reduction. Many other considerations remain. For example, the transducer cable can limit measurement system frequency response for both quartz ICP® and MEMS transducers. First, for MEMS transducers, cable resistance can lessen the supply voltage reaching their resistive bridge thus lowering the signal output. For quartz ICP® transducers, the cable capacitance can act as a single-pole filter, resulting in signal attenuation at higher frequencies. This can be compensated for by supplying a higher drive current to the ICP® circuit. At very high frequencies, for both ICP® and MEMS transducers, both the cable capacitance and inductance must be considered. To avoid reflections in the cable, with resultant data distortion, the input impedance of the recorder must be matched to that of the cable.

Subsequently signal conditioning for amplitude and phase response must also be considered. Finally, all signals should be digitized at nominal rates of 1 MHz with at least 16 bit resolution to assure data accuracy for peak pressure determination and data integration.

The requirements of this section are not unique to static overpressure measurements. They are of concern to other test engineers involved with measuring reflected blast pressures, accelerometer pyrotechnic shock measurements, and more. Reference 9 discusses most of these considerations.

Finally, the noise floor of the instrumentation system must be quantified. This noise definition includes not only the traditional electrostatic, electromagnetic, and ground loop induced noise considerations, but also noise due to environmental inputs such as mounting plate strain coupling into the measuring transducers. Specific data channels must be allocated to determine the magnitude of this noise. This determination involves placing transducers in blind holes, using placebo transducers to replace quartz ICP® transducers, using MEMS transducers with no power applied, and more. This logical activity has also been described [7,9].

## CONCLUSIONS

This paper has described the types of transducers that must be used to measure static overpressure. Their required mounting has also been described along with their placement in application. Potential measurement errors due to thermal stimuli, mechanical strain stimuli, and the impact of fragments from the case of the explosive item on the measuring transducer have all been discussed. Still other potential error sources exist. Once all of these issues are resolved, the requisite

design considerations of the remainder of the system must be incorporated. These considerations include: cable selection, power, measurement system transfer function, data sample rate, bit resolution, and more. Finally, the noise floor documentation of the measurement system must occur. If the guidance of this paper is followed, and system noise is validated to be small enough to be compatible with data accuracy requirements, then the resultant data can be certified as valid to be used in analysis.

## REFERENCES

1. Ruetenik, J. Ray, Pressure Probe and System for Measuring Large Blast Waves, Air Force Flight Dynamics Laboratory, Research and Technology Division, Wright-Patterson AFB, Ohio, FDL-TDR-65-35, June 1965.
2. Cole, Eldine, Air Blast Measurement Technology, Kaman Sciences Corporation, report number K-76-38U(R), sponsored by Defense Nuclear Agency, contract DNA001-76-C-0088, September 1976.
3. Signal Conditioning Basics for ICP® and Charge Output Signals, [www.pcb.com](http://www.pcb.com)
4. Silver, P. L., "Evaluation of Air Blast Measurement Techniques", 75th Shock and Vibration Proceedings, Virginia Beach, VA, October 17 - 22, 2004.
5. Kinney, Gilbert E., Graham, Kenneth J., Explosive Shocks in Air, Springer-Verlag, New York, 2nd ed., 1985.
6. Bittle, Robert, Heat Transfer Analysis of a Probe/Sensor Element Assembly, Texas Christian University, Fort Worth, TX, unpublished Sept. 26, 2006.
7. Walter, Patrick L., Air-blast and the Science of Dynamic Pressure Measurements, Sound and Vibration, pp. 10-16, December 2004.
8. Baker, Wilfred E, Explosions in Air, University of Texas Press, pp. 4-8, 1973.
9. Walter, P. L., Validating the Data Before the Structural Model, Experimental Techniques, vol. 34, issue 6, pp. 56-59, Nov./Dec. 2006.