



Model 641B10

4-20 mA Output Velocity Sensor

Installation and Operating Manual

**For assistance with the operation of this product,
contact PCB Piezotronics, Inc.**

**Toll-free: 800-959-4464
24-hour SensorLine: 716-684-0001
Fax: 716-684-3823
E-mail: imi@pcb.com
Web: www.imi-sensors.com**



Repair and Maintenance

PCB guarantees Total Customer Satisfaction through its “Lifetime Warranty Plus” on all Platinum Stock Products sold by PCB and through its limited warranties on all other PCB Stock, Standard and Special products. Due to the sophisticated nature of our sensors and associated instrumentation, **field servicing and repair is not recommended and, if attempted, will void the factory warranty.**

Beyond routine calibration and battery replacements where applicable, our products require no user maintenance. Clean electrical connectors, housings, and mounting surfaces with solutions and techniques that will not harm the material of construction. Observe caution when using liquids near devices that are not hermetically sealed. Such devices should only be wiped with a dampened cloth—never saturated or submerged.

In the event that equipment becomes damaged or ceases to operate, our Application Engineers are here to support your troubleshooting efforts 24 hours a day, 7 days a week. Call or email with model and serial number as well as a brief description of the problem.

Calibration

Routine calibration of sensors and associated instrumentation is necessary to maintain measurement accuracy. We recommend calibrating on an annual basis, after exposure to any extreme environmental influence, or prior to any critical test.

PCB Piezotronics is an ISO-9001 certified company whose calibration services are accredited by A2LA to ISO/IEC 17025, with full traceability to SI through N.I.S.T. In addition to our standard calibration services, we also offer specialized tests, including: sensitivity at elevated or cryogenic temperatures, phase response, extended high or low frequency response, extended range, leak testing, hydrostatic pressure testing, and others. For more information, contact your local PCB Piezotronics distributor, sales representative, or factory customer service representative.

Returning Equipment

If factory repair is required, our representatives will provide you with a Return Material Authorization (RMA) number, which we use to reference any information you have already provided and expedite the repair process. This number should be clearly marked on the outside of all returned package(s) and on any packing list(s) accompanying the shipment.

Contact Information

PCB Piezotronics, Inc.
3425 Walden Ave.
Depew, NY14043 USA
Toll-free: (800) 828-8840
24-hour SensorLine: (716) 684-0001
General inquiries: info@pcb.com
Repair inquiries: rma@pcb.com

For a complete list of distributors, global offices and sales representatives, visit our website, www.pcb.com.

Safety Considerations

This product is intended for use by qualified personnel who recognize shock hazards and are familiar with the precautions required to avoid injury. While our equipment is designed with user safety in mind, the protection provided by the equipment may be impaired if equipment is used in a manner not specified by this manual.

Discontinue use and contact our 24-Hour Sensorline if:

- Assistance is needed to safely operate equipment
- Damage is visible or suspected
- Equipment fails or malfunctions

For complete equipment ratings, refer to the enclosed specification sheet for your product.

Definition of Terms and Symbols

The following symbols may be used in this manual:



DANGER

Indicates an immediate hazardous situation, which, if not avoided, may result in death or serious injury.

**CAUTION**

Refers to hazards that could damage the instrument.

**NOTE**

Indicates tips, recommendations and important information. The notes simplify processes and contain additional information on particular operating steps.

The following symbols may be found on the equipment described in this manual:



This symbol on the unit indicates that high voltage may be present. Use standard safety precautions to avoid personal contact with this voltage.



This symbol on the unit indicates that the user should refer to the operating instructions located in the manual.



This symbol indicates safety, earth ground.



PCB工业监视和测量设备 - 中国RoHS2公布表

PCB Industrial Monitoring and Measuring Equipment - China RoHS 2 Disclosure Table

部件名称	有害物质					
	铅 (Pb)	汞 (Hg)	镉 (Cd)	六价铬 (Cr(VI))	多溴联苯 (PBB)	多溴二苯醚 (PBDE)
住房	0	0	0	0	0	0
PCB板	X	0	0	0	0	0
电气连接器	0	0	0	0	0	0
压电晶体	X	0	0	0	0	0
环氧	0	0	0	0	0	0
铁氟龙	0	0	0	0	0	0
电子	0	0	0	0	0	0
厚膜基板	0	0	X	0	0	0
电线	0	0	0	0	0	0
电缆	X	0	0	0	0	0
塑料	0	0	0	0	0	0
焊接	X	0	0	0	0	0
铜合金/黄铜	X	0	0	0	0	0
本表格依据 SJ/T 11364 的规定编制。						
0：表示该有害物质在该部件所有均质材料中的含量均在 GB/T 26572 规定的限量要求以下。						
X：表示该有害物质至少在该部件的某一均质材料中的含量超出 GB/T 26572 规定的限量要求。						
铅是欧洲RoHS指令2011/65/ EU附件三和附件四目前由于允许的豁免。						

CHINA RoHS COMPLIANCE

Component Name	Hazardous Substances					
	Lead (Pb)	Mercury (Hg)	Cadmium (Cd)	Chromium VI Compounds (Cr(VI))	Polybrominated Biphenyls (PBB)	Polybrominated Diphenyl Ethers (PBDE)
Housing	O	O	O	O	O	O
PCB Board	X	O	O	O	O	O
Electrical Connectors	O	O	O	O	O	O
Piezoelectric Crystals	X	O	O	O	O	O
Epoxy	O	O	O	O	O	O
Teflon	O	O	O	O	O	O
Electronics	O	O	O	O	O	O
Thick Film Substrate	O	O	X	O	O	O
Wires	O	O	O	O	O	O
Cables	X	O	O	O	O	O
Plastic	O	O	O	O	O	O
Solder	X	O	O	O	O	O
Copper Alloy/Brass	X	O	O	O	O	O

This table is prepared in accordance with the provisions of SJ/T 11364.

O: Indicates that said hazardous substance contained in all of the homogeneous materials for this part is below the limit requirement of GB/T 26572.

X: Indicates that said hazardous substance contained in at least one of the homogeneous materials for this part is above the limit requirement of GB/T 26572.

Lead is present due to allowed exemption in Annex III or Annex IV of the European RoHS Directive 2011/65/EU.

Model 640/641/645/646 B Series Industrial 4-20mA Sensor



Operating Guide with Enclosed Warranty Information

3425 Walden Avenue, Depew, New York 14043-2495

Phone (716) 684-0003

Fax (716) 684-3823

Toll Free Line 1-800-959-4IMI

Table of Contents

Introduction..... Page 3
 General Features

Dimension Drawing Page 4

Operation and Wiring Page 5
 Standard Wiring
 Taking Measurements
 RV Option
 RVVO Option
 TO Option

Installation Page 9
 Direct Adhesive Mount
 Standard Stud Mount
 Adhesive Stud Mount
 Magnetic Mount

ESD Sensitivity..... Page 13

Warranty/Service

Warranty, Service & Return Procedure Page 14

Customer Service..... Page 15

Introduction

The Model 640/641/645/646 B Series Industrial 4-20mA Sensors combine the capabilities of a piezoelectric vibration sensor and a 4-20mA vibration transmitter. The sensor outputs a 4-20mA signal that is proportional to the overall velocity or acceleration of the machinery. Ideal for monitoring the vibration of process equipment such as fans, motors and pumps, the output of the sensor is used for process control or predictive maintenance. There are many options in this series. Please refer to specific specification sheets for further details.

General Features

- Imbedded Piezoelectric Accelerometer for improved accuracy and frequency response.
- Vibration range can be in Acceleration or Velocity.
- Allows for continuous vibration monitoring of critical applications.
- Reduces sophisticated vibration analysis requirements.
- RV (Raw Vibration) option for conducting frequency analysis and machinery diagnostics.
- RVVO (Raw Vibration Velocity Output) option for conducting freq. analysis and machinery diagnosis.
- TO (Temperature Output) option via an independent 4-20mA loop.
- Readily interfaces to existing process control and predictive maintenance equipment.
- Rugged stainless steel construction for applications in harsh environments.
- Flexible design allows for various custom requirements.

Dimension Drawing

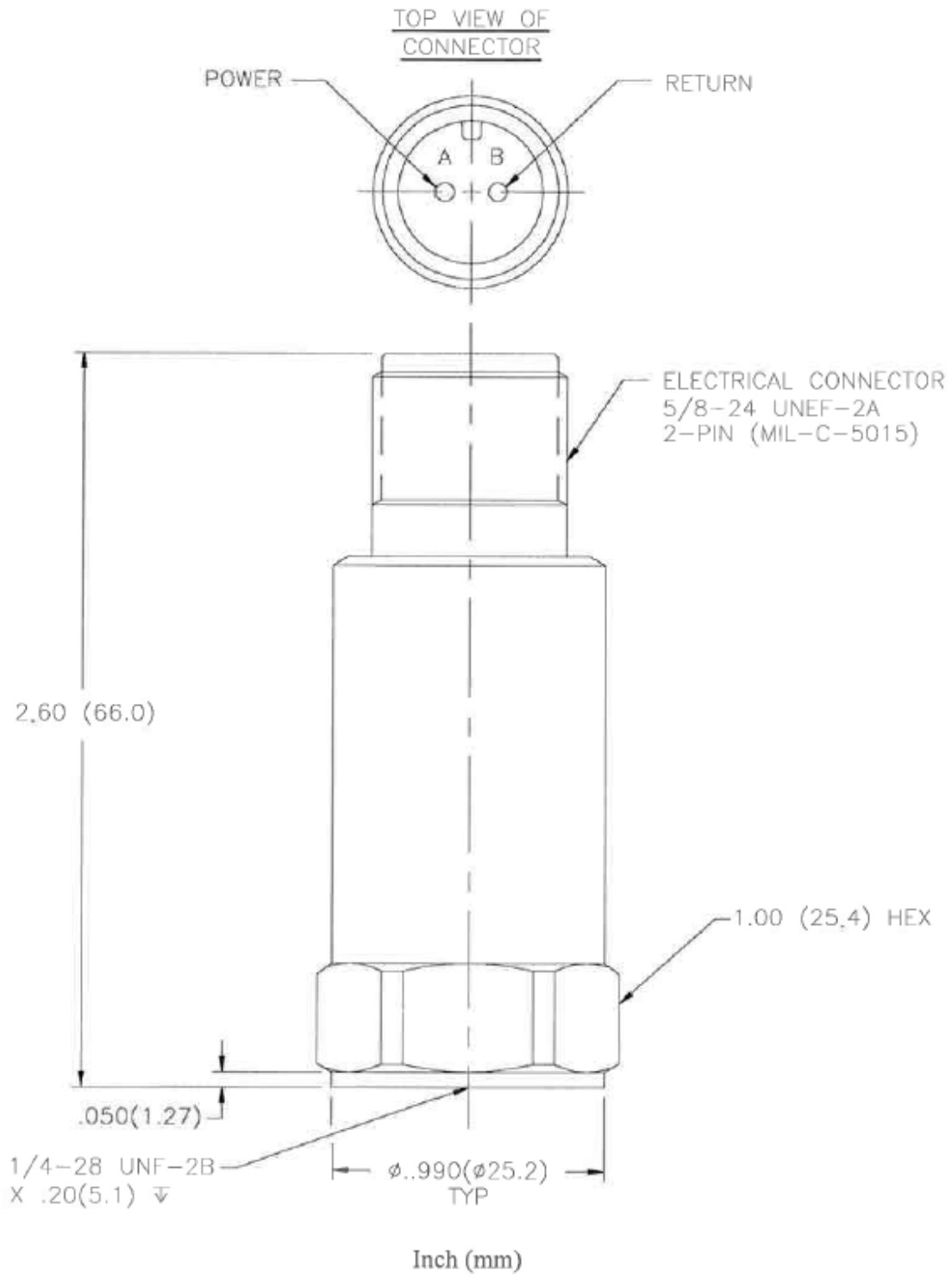

Operation and Wiring

Standard Wiring

The Model 640/641/645/646 B Series operates from a standard 2-Wire, 4-20mA loop. If using a loop powered unit, attach the positive (+) input from the power supply to Pin A or **Red** wire on the sensor and the negative (-) input from the power supply to Pin B or **Blue** Wire of the sensor.

Figure 1 – wiring: loop powered

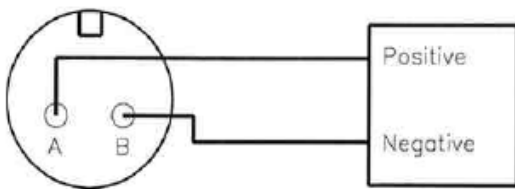
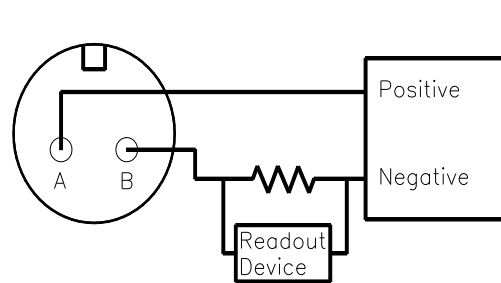

Figure 2 – wiring: loop powered/DC source



If using a standard DC power supply, install either an ammeter and/or load resistor in line with the output, Pin B or **Blue** Wire.

The resistor will generate a DC voltage that is proportional to current by:

$$V = IR$$

$$\text{If } R = 500 \text{ ohms and } I = 6 \text{ mA, then } V = 3 \text{ VDC}$$

Note:

- Resistor value must be less than: $(V_{\text{supply}} - 12) \times 50$.
- For integral cable sensors: RED wire is positive, BLUE wire is negative.

Taking Measurements

When measuring the current output from the unit, use the following formula to calculate the vibration level:

$$\text{Vibration Output} = (\text{Measured Output} - 4\text{mA}) \times (\text{Full Scale Vibration Output} / 16\text{mA})$$

Measured mA	640BX0	640BX1	640BX2
4.00	0.0 ips, pk	0.0 ips, pk	0.0 ips, pk
8.00	0.125 ips, pk	0.25 ips, pk	0.5 ips, pk
12.0	0.25 ips, pk	0.5 ips, pk	1.0 ips, pk
15.75	0.37 ips, pk	0.73 ips, pk	1.47 ips, pk
20	0.5 ips, pk	1.0 ips, pk	2.0 ips, pk

Measured mA	641BX0	641BX1	641BX2
4.00	0.0 ips, rms	0.0 ips, rms	0.0 ips, rms
8.00	0.125 ips, rms	0.25 ips, rms	0.5 ips, rms
12.0	0.25 ips, rms	0.5 ips, rms	1.0 ips, rms
15.75	0.37 ips, rms	0.73 ips, rms	1.47 ips, rms
20	0.5 ips, rms	1.0 ips, rms	2.0 ips, rms

Measured mA	645	646
4.00	0.0 g rms	0.0 g rms
8.00	1.25 g rms	2.50 g rms
12.0	2.50 g rms	5.00 g rms
15.75	3.67 g rms	7.34 g rms
20	5.00 g rms	10.0 g rms

RV Option

The RV (raw vibration) option includes a 100mV/g $\pm 20\%$ additional output. The accelerometer frequency range is 1 Hz-1 kHz, maximum amplitude of 15 g-pk. Data collectors or analyzers can use this vibration signal for further analysis. This output is extended to the RVVO (Raw Vibration Velocity Output) option, which integrates the signal to a value of 100 mV/IPS ($\pm 20\%$).

Figure 3 – RV and RVVO wiring

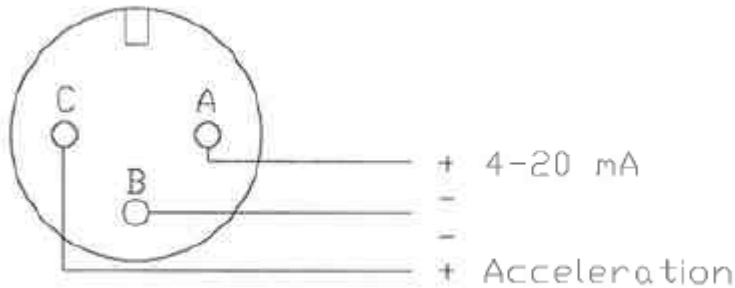

For integral cable sensors:

RED	4-20mA Positive
BLACK	4-20mA Negative (same as green)
GREEN	-RV and RVVO negative (same as black)
WHITE	+RV and RVVO positive

Note:

-The RV and RVVO Signal Negative has to be isolated from any grounding. If this terminal is grounded, the 4-20mA loop will short, causing no output.

-The RV and RVVO output signal is ideally suited for use with portable battery powered data collectors or analyzers.

TO Option

The TO (Temperature Output) option includes an additional independent 4-20mA output for temperature measurement. The temperature range is from -40°C to 125°C with an overall accuracy of $\pm 5\%$ FSO. The imbedded temperature sensor monitors the environment internal to the sensor housing and is situated at approximately mid level.

Figure 4 – TO wiring

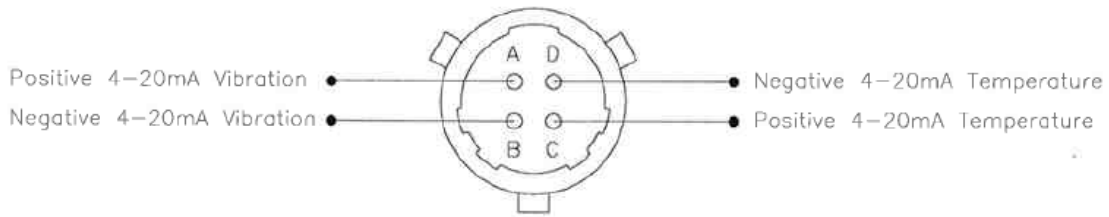

For integral cable sensors:

RED	4-20mA Vibration Positive
BLACK	4-20mA Vibration Negative
GREEN	4-20mA Temperature Negative
WHITE	4-20mA Temperature Positive

Note:

- The same power supply can be used for both 4-20mA loops. Connect both positive terminals directly to the power supply, then use the negative terminals for independent process loops.

Installation

When choosing a mounting method, consider closely the advantages and disadvantages of each technique. Typical mounting types are stud, direct adhesive, adhesive mounting base and magnetic mounting base. Since the frequency response is limited to 1 kHz on the 640/641, any of the four methods can be used without seriously affecting the data values. The mounting method might affect some of the 645/646 series because of the increased frequency response.

Direct Adhesive Mount Procedure

For restrictions of space or for convenience, most sensors (with the exception of integral stud models) can be adhesive-mounted directly to the machine surface.

STEP 1 Prepare a smooth, flat surface. A minimum surface finish of 63 μin [0.0016 mm] generally works best.

STEP 2 Place a small portion of adhesive on the underside of the sensor. Firmly press down on the top of the assembly to displace any adhesive. Be aware that excessive amounts of adhesive can make sensor removal difficult.

Figure 5– direct adhesive mounting

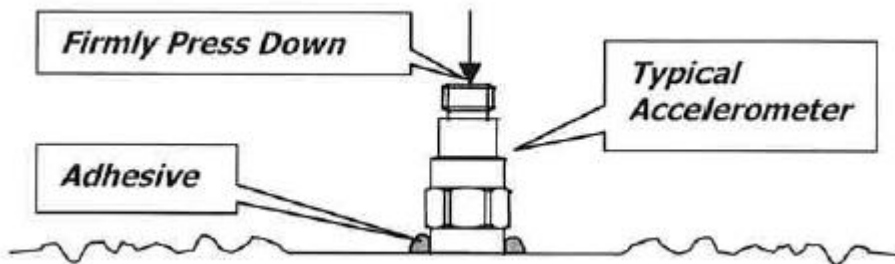

Standard Stud Mount Procedure

This mounting technique requires smooth, flat contact surfaces for proper operation and is recommended for permanent and/or secure installations. Stud mounting is also recommended when testing at high frequencies.

Note: DO NOT attempt mounting on curved, rough or uneven surfaces, as the potential for misalignment and limited contact surface may significantly reduce the sensor's upper operating frequency range.

Figure 6– direct adhesive mounting

<u>1/4-28 stud</u>	<u>1/4-28 Captive Screw-*</u>	
A (in)	0.250	0.250
B (in)	0.350	0.350
Torque (ft-lb)	2 to 5	2 to 5

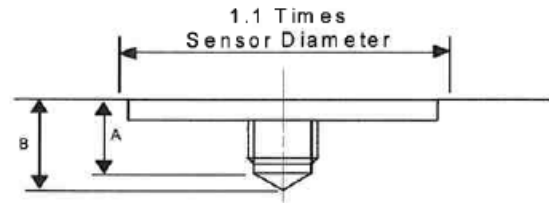

STEP 1 First, prepare a smooth, flat mounting surface, and then drill and tap a mounting hole in the center of this area as shown in Figure 6. A precision-machined mounting surface with a minimum finish of 63 μin [0.0016 mm] is recommended. (If it is not possible to properly prepare the machine surface, consider using an adhesive mounting pad as a possible alternative.) Inspect the area, checking that there are no burrs or other foreign particles interfering with the contact surface.

STEP 2 Wipe clean the mounting surface and spread on a light film of grease, oil or similar coupling fluid prior to installation.

Figure 7– mounting surface lubrication.



Adding a coupling fluid improves vibration transmissibility by filling small voids in the mounting surface and increasing the mounting stiffness. For semi-permanent mounting, substitute epoxy or another type of adhesive.

STEP 3 HAND – tighten the sensor/mounting stud to the machine, then secure the sensor with a torque wrench to the mounting surface by applying the recommended mounting torque (see enclosed specification data sheet for proper mounting torque). It is important to use a torque wrench during this step. **Under-torquing the sensor may not adequately couple the device; over-torquing may result in stud failure and possible permanent damage.**

Adhesive Stud Mount Procedure

Adhesive mounting is often used for temporary installation or when the machine surface cannot be adequately prepared for stud mounting. Adhesives like hot glue or wax work well for temporary mounts; two-part epoxies and quick –bonding gels provide a more permanent mount.

Note: Adhesively mounted sensors often exhibit a reduction in high-frequency range. Generally, smooth surfaces and stiff adhesives provide the best frequency response.

This method involves attaching a base to the machine surface, then securing the sensor to the base. This allows for easy removal of the accelerometer.

STEP 1 Prepare a smooth, flat mounting surface. A minimum surface finish of 63 μin [0.0016 mm] generally works best.

STEP 2 Stud-mount the sensor to the appropriate adhesive mounting base according to the guidelines set forth in Steps 2 and 3 of the *Standard Stud Mount Procedure*.

STEP 3 Place a small portion of adhesive on the underside of the mounting base. Firmly press down on the assembly to displace any extra adhesive remaining under the base.

Figure 8– mounting base: adhesive installation



Magnetic Mount Procedure

Magnetic mounting provides a convenient means for making portable measurements and is commonly used for machinery monitoring and other portable or tending applications.

Note: The correct magnet choice and an adequately prepared mounting surface is critical for obtaining reliable measurements, especially at high frequencies. Poor installations can cause as much as a 50% drop in the sensor frequency range.

Not every magnet is suitable for all applications. For example, rare earth magnets are commonly used because of their high strength. Flat magnets work well on smooth, flat surfaces, while dual-rail magnets are required for curved surfaces. In the case of non-magnetic or rough surfaces, it is recommended that the user first weld, epoxy or otherwise adhere a steel mounting pad to the test surface. This provides a smooth and repeatable location for mounting.

Figure 9– magnet types

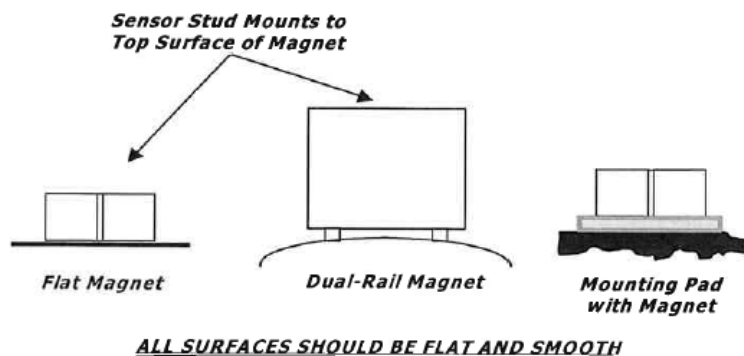

STEP 1 After choosing the correct magnet type, inspect the unit, verifying that the mounting surfaces are flat and smooth.

STEP 2 Stud- mount the accelerometer to the appropriate magnet according to the guidelines set forth in Steps 2 and 3 of the Standard Stud Mount Procedure.

STEP 3 Prepare a smooth, flat mounting surface. A minimum surface finish of 63 μin [0.0016 mm] generally works best. After cleaning the surface and checking for burrs, wipe on a light film of silicone grease, machine oil or similar-type coupling fluid.

STEP 4 Mount the magnet/sensor assembly to the prepared test surface by gently ‘rocking’ or ‘sliding’ it into place.

Note: Magnetically mounting accelerometers carelessly as the potential to generate very high (and very damaging) g levels. To prevent damage, install the assembly gently. If unsure, please contact the factory for assistance.

Warning 1 – ESD sensitivity

The power supply/signal conditioner should not be opened by anyone other than qualified service personnel. This product is intended for use by qualified personnel who recognize shock hazards and are familiar with the safety precautions required to avoid injury.

Warning 2 – ESD sensitivity

This equipment is designed with user safety in mind; however, the protection provided by the equipment may be impaired if the equipment is used in a manner not specified by PCB Piezotronics, Inc.

Caution 1 – ESD sensitivity

Cables can kill your equipment. High voltage electrostatic discharge (ESD) can damage electrical devices. Similar to a capacitor, a cable can hold a charge caused by triboelectric transfer, such as that which occurs in the following:

- *Laying on and moving across a rug,*
- *Any movement through air,*
- *The action of rolling out a cable, and/or*
- *Contact with a non-grounded person.*

The solution for product safety:

- *Connect the cables only with the AC power off.*
- *Temporarily “short” the end of the cable before attaching it to any signal input or output.*

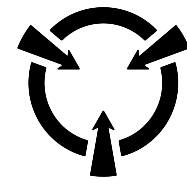

CAUTION
ELECTROSTATIC
DISCHARGE SENSITIVE

Caution 2 – ESD sensitivity

ESD considerations should be made prior to performing any internal adjustments on the equipment. Any piece of electronic equipment is vulnerable to ESD when opened for adjustments. Internal adjustments should therefore be done ONLY at an ESD-safe work area. Many products have ESD protection, but the level of protection may be exceeded by extremely high voltage.

Warranty

IMI instrumentation is warranted against defective material workmanship for 1 year unless otherwise expressly specified. Damage to instruments caused by incorrect power or misapplication, is not covered by warranty. *If there are any questions regarding power, intended application, or general usage, please consult with your local sales contact or distributor.* Batteries or expendable hardware items are not covered by warranty.

Service

Because of the sophisticated nature of IMI instrumentation, field repair is typically **NOT** recommended and may void any warranty. If factory service is required, return the instrumentation according to the "Return Procedure" stated below. *A repair and/or replacement quotation will be provided prior to servicing at no charge.* Before returning the unit, please consult a factory IMI applications engineer concerning the situation as certain problems can often be corrected with simple on-site procedures.

Return procedure

To expedite returned instrumentation, contact a factory IMI applications engineer for RETURN MATERIAL AUTHORIZATION (RMA) NUMBER. Please have information available such as model and serial number. Also, to insure efficient service, *provide a written description of the symptoms and problems with the equipment to a local sales representative or distributor, or contact IMI if none are located in your area.*

Customers outside the U.S. should consult their local IMI distributor for information on returning equipment. For exceptions, please contact that International Sales department at IMI to request shipping instructions and an RMA. For assistance, please call (716) 684-0003, or fax us at (716) 684-3823. You may also receive assistance via e-mail at imi@pcb.com or visit our website at www.pcb.com.

Customer Service

IMI, a division of PCB Piezotronics, guarantees **Total Customer Satisfaction**. If, at any time, for any reason, you are not completely satisfied with any IMI product, IMI will repair, replace or exchange it at no charge. You may also choose to have your purchase price refunded.

IMI offers to all customers, at no charge, 24-hour phone support. This service makes product or application support available to our customers, day or night, seven days a week. When unforeseen problems or emergency situations arise, call the **IMI Hot Line at (716) 684-0003**, and an application specialist will assist you.

Model Number
641B10

LOOP POWERED, CURRENT OUTPUT, INDUSTRIAL VIBRATION SENSOR

Revision: A
ECN #: 25910

	ENGLISH	SI	
Performance			
Measurement Range	0.0 to 0.5 in/s rms	0.0 to 12.7 mm/s rms	[1][2]
Output	4-20 mA	4-20 mA	
Frequency Range(± 10 %)	600 to 60,000 cpm	10 to 1 kHz	[3][4]
Broadband Resolution	0.005 in/s pk	0.13 mm/s pk	[5]
Non-Linearity	± 1 %	± 1 %	
Environmental			
Temperature Range	-40 to 185 °F	-40 to 85 °C	
Electrical			
Excitation Voltage	12 to 30 VDC	12 to 30 VDC	
Settling Time(within 2% of value)	<15 sec	<15 sec	
Electrical Isolation(Case)	>10 ⁸ ohm	>10 ⁸ ohm	
Physical			
Size (Hex x Height)	1.0 in x 4.2 in	25.4 mm x 107 mm	
Weight(without cable)	4.7 oz	131 gm	
Mounting Thread	1/4-28 UNF	Not Applicable	
Mounting Torque	3 to 5 ft-lb	4 to 7 N-m	
Sensing Element	Ceramic	Ceramic	
Sensing Geometry	Shear	Shear	
Housing Material	Stainless Steel	Stainless Steel	
Sealing	Welded Hermetic	Welded Hermetic	
Electrical Connector	Integral Cable	Integral Cable	
Electrical Connection Position	Top	Top	
Electrical Connections(Red)	4-20 mA Pos (+)	4-20 mA Pos (+)	
Electrical Connections(Blue)	4-20 mA Neg (-)	4-20 mA Neg (-)	
Cable Length	10 ft	3.0 m	
Cable Type	Polyurethane	Polyurethane	

OPTIONAL VERSIONS
Optional versions have identical specifications and accessories as listed for the standard model except where noted below. More than one option may be used.

EX - ATEX or ATEX and CSA Hazardous Area Approval
 Hazardous Area Approval EEx ia IIC T4, -40°C≤Tas80°C, II 1 G
 Hazardous Area Approval EEx nL IIC T4, -40°C≤Tas80°C, II 3 G
 Hazardous Area Approval DIV I, CL I, II, III, GRPS A-G, Exia, AExia, IIC T4
 Hazardous Area Approval DIV II, CL I, GRPS A-D, ExnL, AExnA, IIC T4

M - Metric Mount
Supplied Accessory : Model M081A61 Mounting Stud 1/4-28 to M6 X 1 (1) replaces Model 081A40

RV - Buffered Analog Signal Output - 100 mV/g (±20%)
 Electrical Connector Integral Cable
 Electrical Connections(Red) 4-20 mA Pos (+)
 Electrical Connections(Black) 4-20 mA Neg (-)
 Electrical Connections(White) Signal Output Pos
 Electrical Connections(Green) Signal Output Neg

NOTES:
 [1] Conversion Factor 1 in/sec = 0.0254 m/sec.
 [2] Maximum frequency for 1 in/sec rms output, 700 Hz.
 [3] Current will fluctuate at frequencies below 5 Hz.
 [4] 1Hz = 60 cpm (cycles per minute).
 [5] Typical.
 [6] See PCB Declaration of Conformance PS039 or PS053 for details.

SUPPLIED ACCESSORIES:
 Model 081A40 Mounting Stud (1)
 Model ICS-4 NIST-traceable single-axis amplitude response calibration from 0 cpm (0 Hz) to upper 10% frequency for 4 - 20 mA output vibration sensor (1)

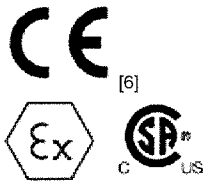

All specifications are at room temperature unless otherwise specified.
 In the interest of constant product improvement, we reserve the right to change specifications without notice.

ICP® is a registered trademark of PCB Group, Inc.

Entered: <i>JH</i>	Engineer: <i>MD</i>	Sales: <i>SPJ</i>	Approved: <i>US</i>	Spec Number:
Date: <i>2-26-07</i>	Date: <i>2/26/07</i>	Date: <i>2/29/07</i>	Date: <i>2/26/07</i>	28149

IMI SENSORS
 A PCB PIEZOTRONICS DIV.
 3425 Walden Avenue, Depew, NY 14043

Phone: 800-959-4464
 Fax: 716-684-3823
 E-Mail: imi@pcb.com

27348

PCB Piezotronics Inc. claims proprietary rights in the information disclosed herein. Neither it nor any reproduction thereof will be disclosed to others without written consent of PCB Piezotronics Inc.

APPLICATION		
NEXT ASS'Y	USED ON	VAR

REVISIONS				
REV	DESCRIPTION	ECN	DATE	APP'D
NR	RELEASED TO DRAFTING		8/30/04	<i>DMH/vz</i>

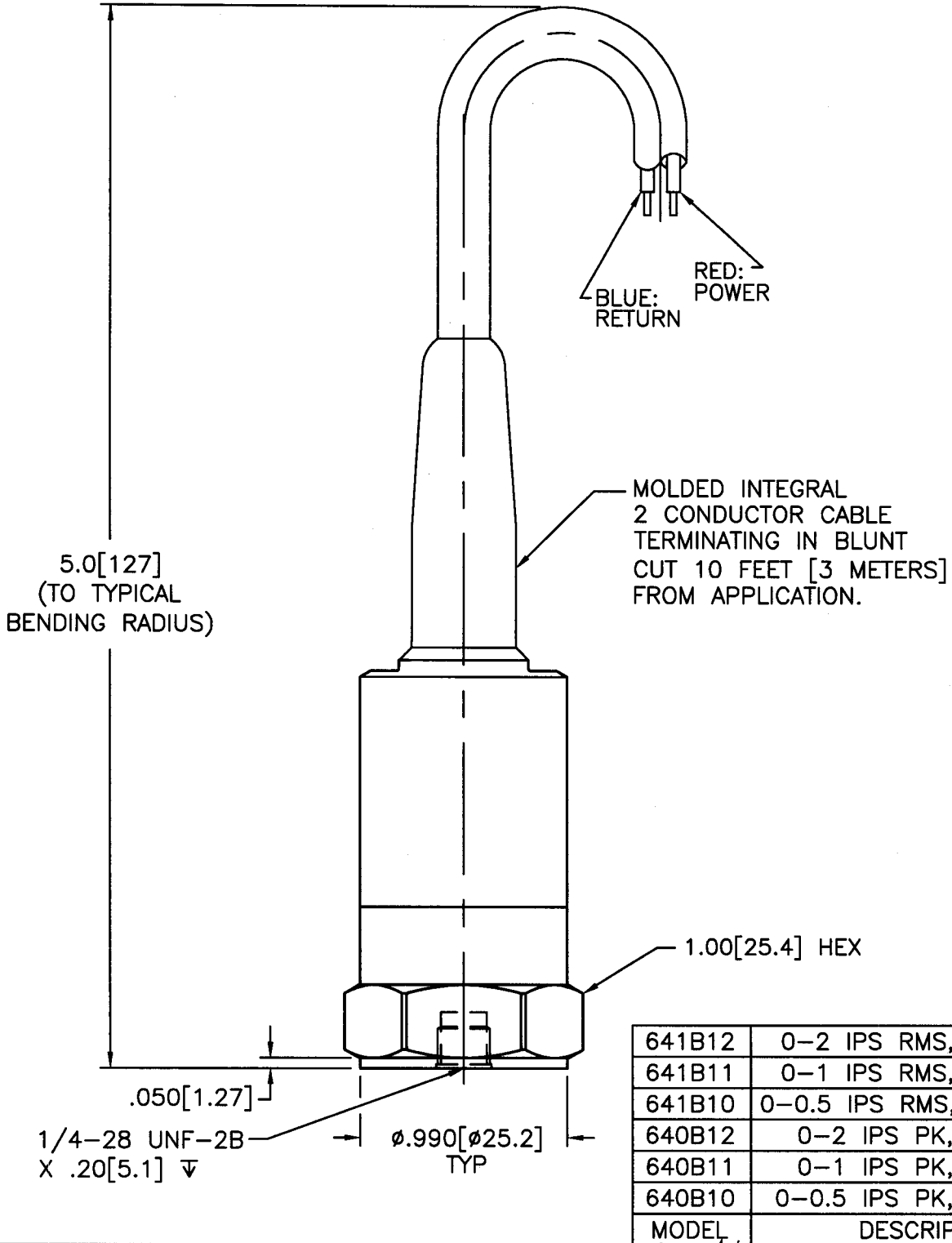

641B12	0-2 IPS RMS, 10Hz-1kHz
641B11	0-1 IPS RMS, 10Hz-1kHz
641B10	0-0.5 IPS RMS, 10Hz-1kHz
640B12	0-2 IPS PK, 3Hz-1kHz
640B11	0-1 IPS PK, 3Hz-1kHz
640B10	0-0.5 IPS PK, 3Hz-1kHz
MODEL	DESCRIPTION

UNLESS SPECIFIED TOLERANCES	
DIMENSIONS IN INCHES	DIMENSIONS IN MILLIMETERS [IN BRACKETS]
DECIMALS XX ±.03	DECIMALS X ±0.8
XXX ±.010	XX ±0.25
ANGLES ±2 DEGREES	ANGLES ±2 DEGREES
FILLET AND RADII .003 - .005	FILLET AND RADII [0.07 - 0.13]

DRAWN	<i>PCE</i>	8/30/04	MFG	<i>BD</i>	9/2/04
CHK'D	<i>DM</i>	9/1/04	ENGR	<i>mz</i>	9/1/04
APP'D	<i>U.A.</i>	9/1/04	SALES	<i>DM</i>	9/2/04
TITLE DRAWING OUTLINE MODEL 640B1X, M, 641B1X, M 4-20 mA VELOCITY TRANSMITTER					

PCB PIEZOTRONICS™
 3425 WALDEN AVE. DEPEW, NY 14043
 (716) 684-0001 EMAIL: SALES@PCB.COM

CODE IDENT. NO. 52681 DWG. NO. 27348

SCALE: 1.33X SHEET 1 OF 1