



Model 691A84

18 Channel (6 Triax) Rotary Triax Switch Box

Installation and Operating Manual

**For assistance with the operation of this product,
contact the PCB Piezotronics, Inc.**

Toll-free: 800-959-4464

24-hour SensorLine: 716-684-0001

Fax: 716-684-3823

E-mail: imi@pcb.com

Web: www.imi-sensors.com



Models (PS)(SS)691A84 6 Channel Triax Switch Box

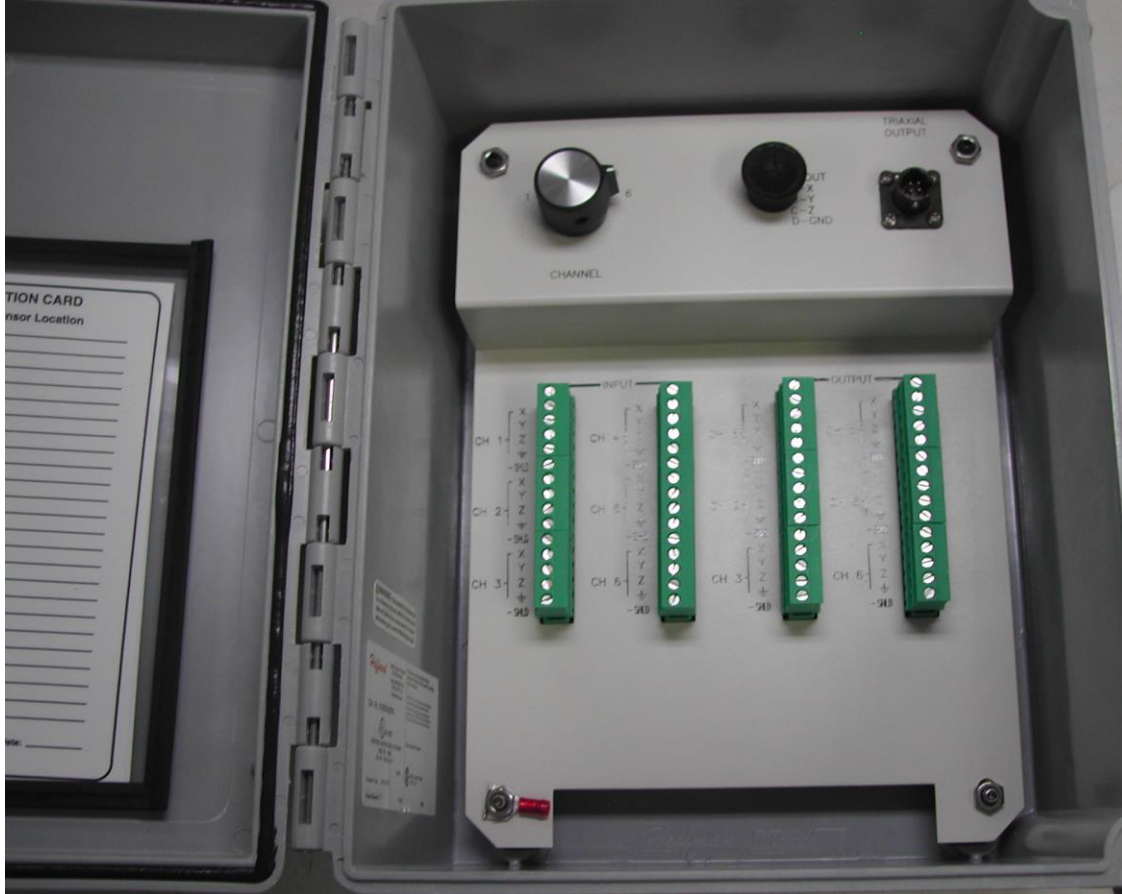

Operating Guide with Enclosed Warranty Information

3425 Walden Avenue, Depew, New York 14043-2495

Phone (716) 684-0003

Fax (716) 684-3823

Toll Free Line 1-800-959-4IMI

MANUAL NUMBER: 68795
MANUAL REVISION: NR
ECO: 48359

Table of Contents

Introduction..... Page 3

Installation Page 4

Grounding the Enclosure Page 5

Input Wiring Page 5

Output Wiring Page 6

Using the Enclosure Page 6

Calibrating the Enclosure Page 6

ESD Warning Information..... Page 7

Warranty/Service

Warranty, Service & Return Procedure Page 8

Customer Service..... Page 9

Introduction

Model 691A84 triax is a switch box that provide terminal strip inputs for triax sensor cable termination with the convenience of a 4-Pin military connectors for switched outputs and terminal strips for continuous outputs. They are typically used in conjunction with third-party data collectors and analyzers. Specifications and drawings are below for reference:

Performance	
Channels	6
Environmental	
Enclosure Rating	IP66(NEMA 4X)
Physical	
Output Connector	4-Pin MIL connector
Input Connector	5-socket screw terminal strip per channel
Continuous Output Connector	5-socket screw terminal strip per channel
Housing Material	Fiberglass Painted Steel (PS prefix) Stainless steel (SS prefix)
Size (excluding latch & mounting access)	10"H x 8"W x 6"D (254 mm x 203mm x 152 mm)
Weight	4.8 lb (2.1 kg)

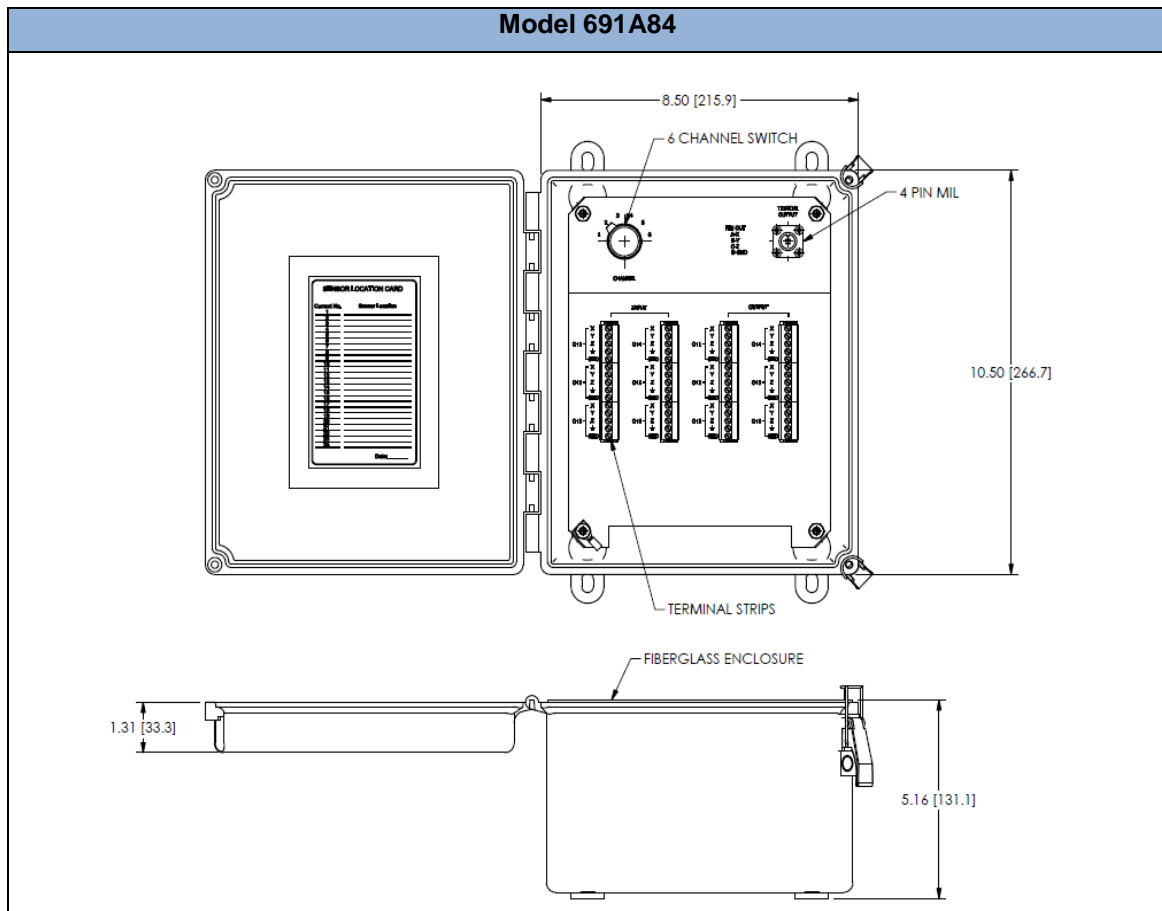

Installation

Establish an easily accessible location for installation.

Fiberglass rotary switch boxes include four polyester mounting brackets and four stainless steel attachment screws that are shipped loose to facilitate enclosure mounting. There are positioning indents on the back of the box in each corner. Once the mounting brackets are positioned properly, they should then be fastened to the box with the provided screws. Hardware for fastening the mounting brackets to the installation surface are to be provided in the field.

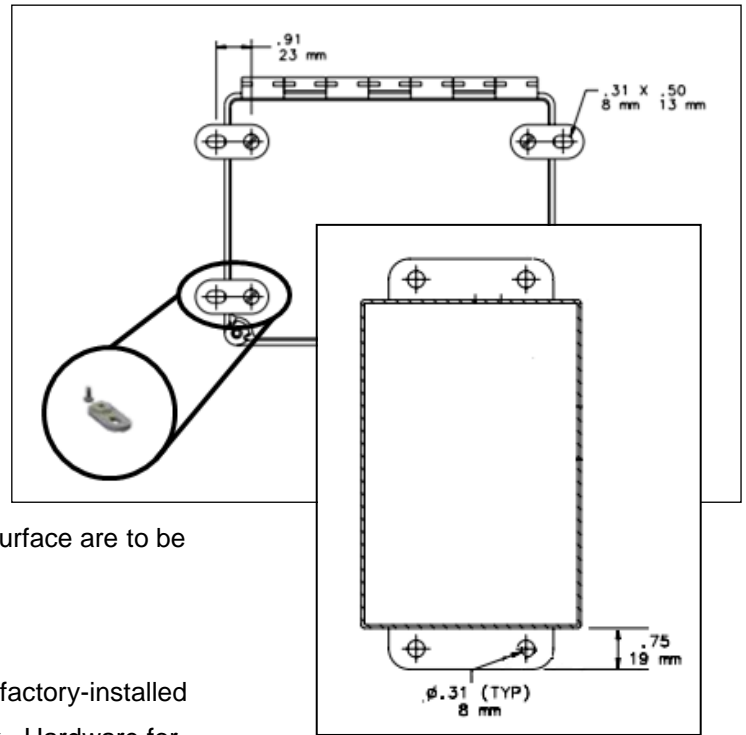

Painted steel and stainless steel boxes include two factory-installed mounting brackets on the top and bottom of the box. Hardware for fastening the mounting brackets to the installation surface are to be provided in the field.

If the box did not ship from factory with factory-installed connections ports, drill/punch the necessary holes in the bottom of box for the input and output cabling. Be very careful when drilling/punching holes in the box as to not damage the internal metal, terminal strips and printed circuit boards. Also, take every possible precaution to prevent water entrainment into the box.

Grounding the Enclosure

Each of the Shield Input and output terminals are connected to the sensor ground input and out terminal block connections. The switch box is supplied with a spade lug which connected to the all Shielded connections. The SS version will always be grounded.

Input Wiring

Sensor cables should be routed through connection ports and then connected to their respective channel's terminal strip per the diagram below. If connection ports are cord grips, cord grips should then be tightened to maintain the enclosure's ingress protection rating.

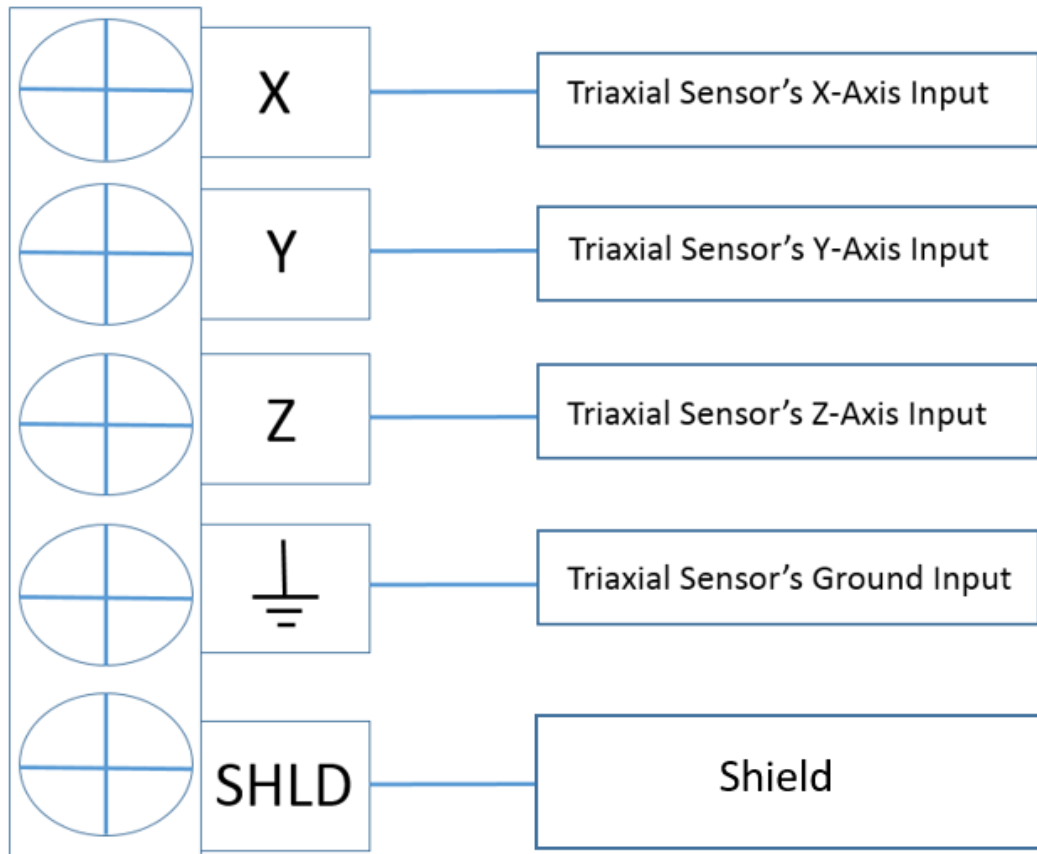

Output Wiring

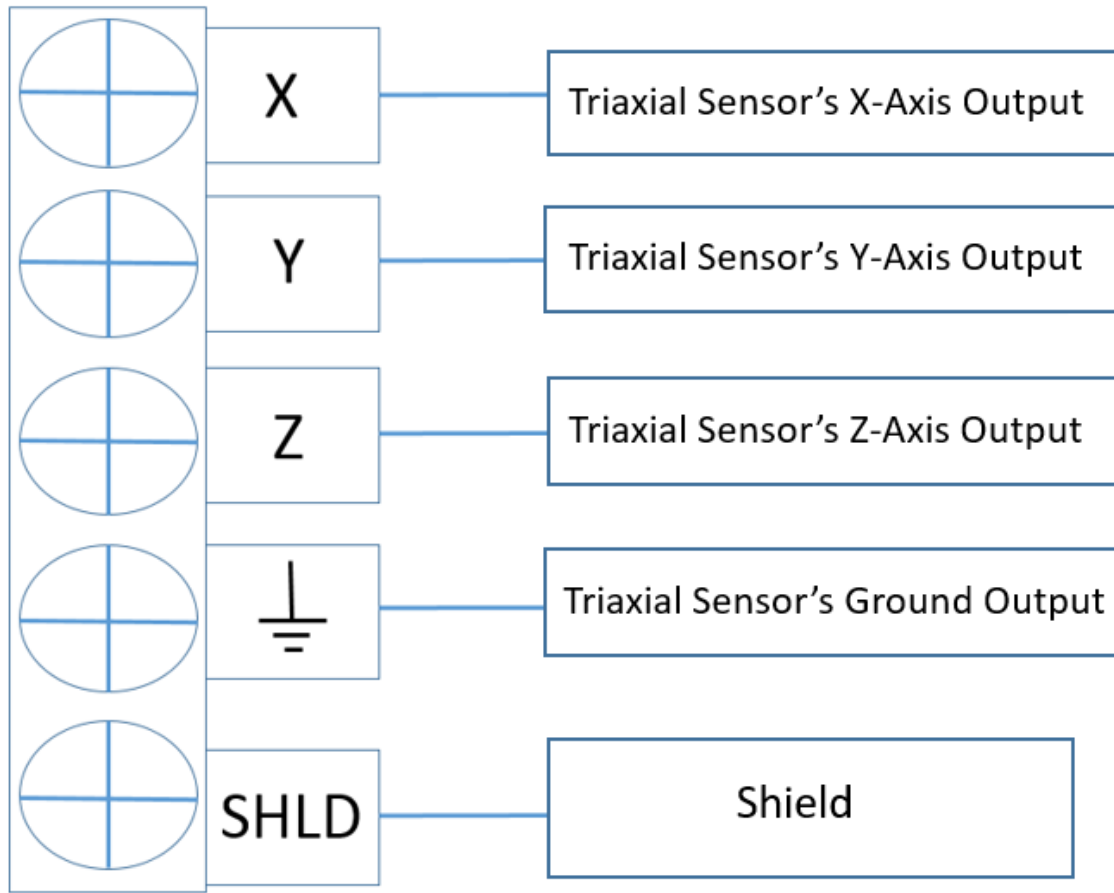

Using the Enclosure

When collecting data from the enclosure using the 4-Pin MIL connector and a data collector, connect the data's collector connector to its appropriate connector mate in the box and modulate the switch to the appropriate channel. If the output terminals are not being used, then the data collector must provide power for the sensor in order to for a signal to be obtained. If the output terminals are being used, then the sensor is already being powered and the data collector does not need to provide power.

Calibrating the Enclosure

The models do not require calibration. If there are any questions concerning the products, please contact the factory.

Warning 1 – ESD Sensitivity

The power supply/signal conditioner should not be opened by anyone other than qualified service personnel. This product is intended for use by qualified personnel who recognize shock hazards and are familiar with the safety precautions required to avoid injury.

Warning 2 – ESD Sensitivity

This equipment is designed with user safety in mind; however, the protection provided by the equipment may be impaired if the equipment is used in a manner not specified by PCB Piezotronics, Inc.

Caution 1 – ESD Sensitivity

Cables can kill your equipment. High voltage electrostatic discharge (ESD) can damage electrical devices. Similar to a capacitor, a cable can hold a charge caused by triboelectric transfer, such as that which occurs in the following:

- *Laying on and moving across a rug,*
- *Any movement through air,*
- *The action of rolling out a cable, and/or*
- *Contact with a non-grounded person.*

The PCB solution for product safety:

- *Connect the cables only with the AC power off.*
- *Temporarily “short” the end of the cable before attaching it to any signal input or output.*

**Caution 2 – ESD Sensitivity**

ESD considerations should be made prior to performing any internal adjustments on the equipment. Any piece of electronic equipment is vulnerable to ESD when opened for adjustments. Internal adjustments should therefore be done ONLY at an ESD-safe work area. Many products have ESD protection, but the level of protection may be exceeded by extremely high voltage.

Warranty

IMI instrumentation is warranted against defective material and workmanship for 1 year unless otherwise expressly specified. Damage to instruments caused by incorrect power or misapplication, is not covered by warranty. *If there are any questions regarding power, intended application, or general usage, please consult with your local sales contact or distributor.* Batteries and other expendable hardware items are not covered by warranty.

Service

Because of the sophisticated nature of IMI instrumentation, field repair is typically **NOT** recommended and may void any warranty. If factory service is required, return the instrumentation according to the "Return Procedure" stated below. *A repair and/or replacement quotation will be provided prior to servicing at no charge.* Before returning the unit, please consult a factory IMI applications engineer concerning the situation as certain problems can often be corrected with simple on-site procedures.

Return Procedure

To expedite returned instrumentation, contact a factory IMI applications engineer for a RETURN MATERIAL AUTHORIZATION (RMA) NUMBER. Please have information available such as model and serial number. Also, to insure efficient service, *provide a written description of the symptoms and problems with the equipment to a local sales representative or distributor, or contact IMI if none are located in your area.*

Customers outside the U.S. should consult their local IMI distributor for information on returning equipment. For exceptions, please contact the International Sales department at IMI to request shipping instructions and an RMA. For assistance, please call (716) 684-0003, or fax us at (716) 684-3823. You may also receive assistance via e-mail at imi@pcb.com or visit our web site at www.pcb.com.

Customer Service

IMI, a division of PCB Piezotronics, guarantees **Total Customer Satisfaction**. If, at any time, for any reason, you are not completely satisfied with any IMI product, IMI will repair, replace, or exchange it at no charge. You may also choose, within the warranty period, to have your purchase price refunded.

IMI offers to all customers, at no charge, 24-hour phone support. This service makes product or application support available to our customers, day or night, seven days a week. When unforeseen problems or emergency situations arise, call the **IMI Hot Line at (716) 684-0003**, and an application specialist will assist you.



3425 Walden Avenue, Depew, NY 14043-2495
Phone: (716) 684-0003 • USA Fax: (716) 684-3823 • INTL Fax: (716) 684-4703

*ICP® is a registered trademark of PCB Piezotronics, Incorporated,
which uniquely identifies PCB sensors that incorporate built-in microelectronics.*

Model Number 691A84	18 CH (6 TRIAX) SWITCH BOX	Revision: NR ECN #: 48359
-------------------------------	-----------------------------------	------------------------------

	<u>ENGLISH</u>	<u>SI</u>
Performance	6	6
Channels(Tri-Ax)		
Environmental		
Enclosure Rating	Nema 4X	IP66
Physical		
Electrical Connector(Output)	4-Pin Bayonet	4-Pin Bayonet
Electrical Connector(Output)	Terminal Block	Terminal Block
Electrical Connector(Input)	Terminal Block	Terminal Block
Housing Material	Fiberglass	Fiberglass
Size (Height x Width x Depth)	10 in x 8 in x 6 in	254 mm x 203 mm x 152 mm
Weight	4.8 lb	2.1 kg

OPTIONAL VERSIONS		
Optional versions have identical specifications and accessories as listed for the standard model except where noted below. More than one option may be used.		
PS - Painted Steel		[3]
Enclosure Rating	Nema 12	IP65
Weight	7 lb	3.2 kg
Size - Height x Width x Depth	10 in x 8 in x 4 in	254 mm x 203 mm x 101 mm
SS - Stainless Steel Enclosure		[3]
Weight	8.8 lb	4 kg
Size - Height x Width x Depth	10 in x 8 in x 4 in	254 mm x 203 mm x 101 mm



All specifications are at room temperature unless otherwise specified.
In the interest of constant product improvement, we reserve the right to change specifications without notice.

NOTES:
 [1] Typical.
 [2] See PCB Declaration of Conformance PS152 for details.
 [3] Mounting kit integral to enclosure.

SUPPLIED ACCESSORIES:
 Model 080A192 4-socket terminal block (1)

Entered: LK	Engineer: gs	Sales: MC	Approved: BAM	Spec Number:
Date: 1/24/2019	Date: 1/24/2019	Date: 1/24/2019	Date: 1/24/2019	68631

 IMI SENSORS A PCB PIEZOTRONICS DIV. 3425 Walden Avenue, Depew, NY 14043	Phone: 800-959-4464 Fax: 716-684-3823 E-Mail: imi@pcb.com
---	--

PCB Piezotronics Inc. claims proprietary rights in the information disclosed hereon. Neither it nor any reproduction thereof will be disclosed to others without the written consent of PCB Piezotronics Inc.

68794

REVISIONS		
REV	DESCRIPTION	DIN
A	UPDATED ARTWORK	49302

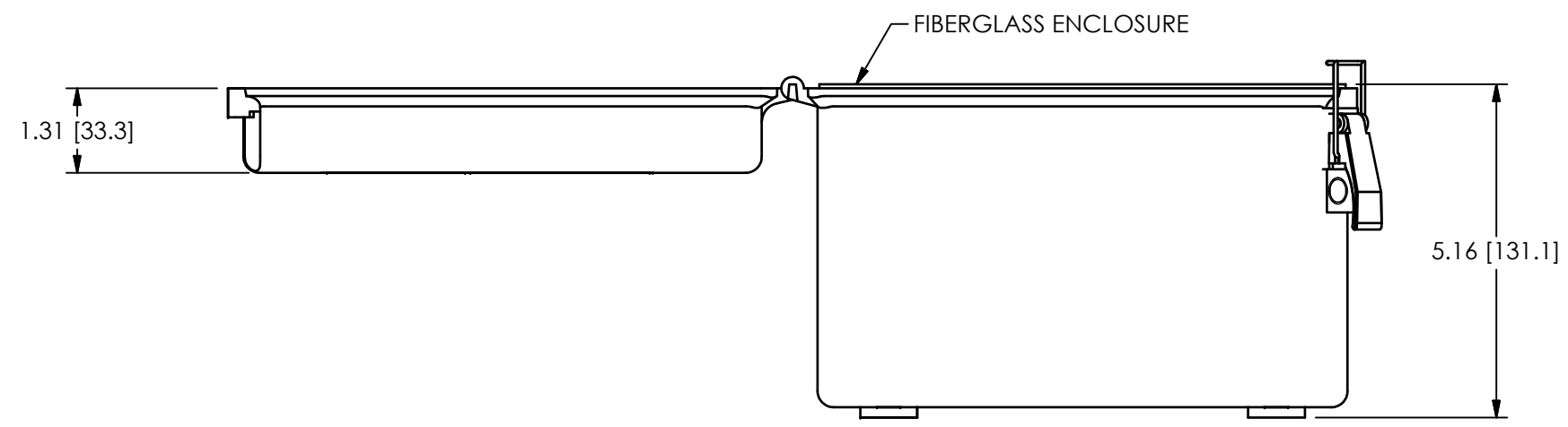
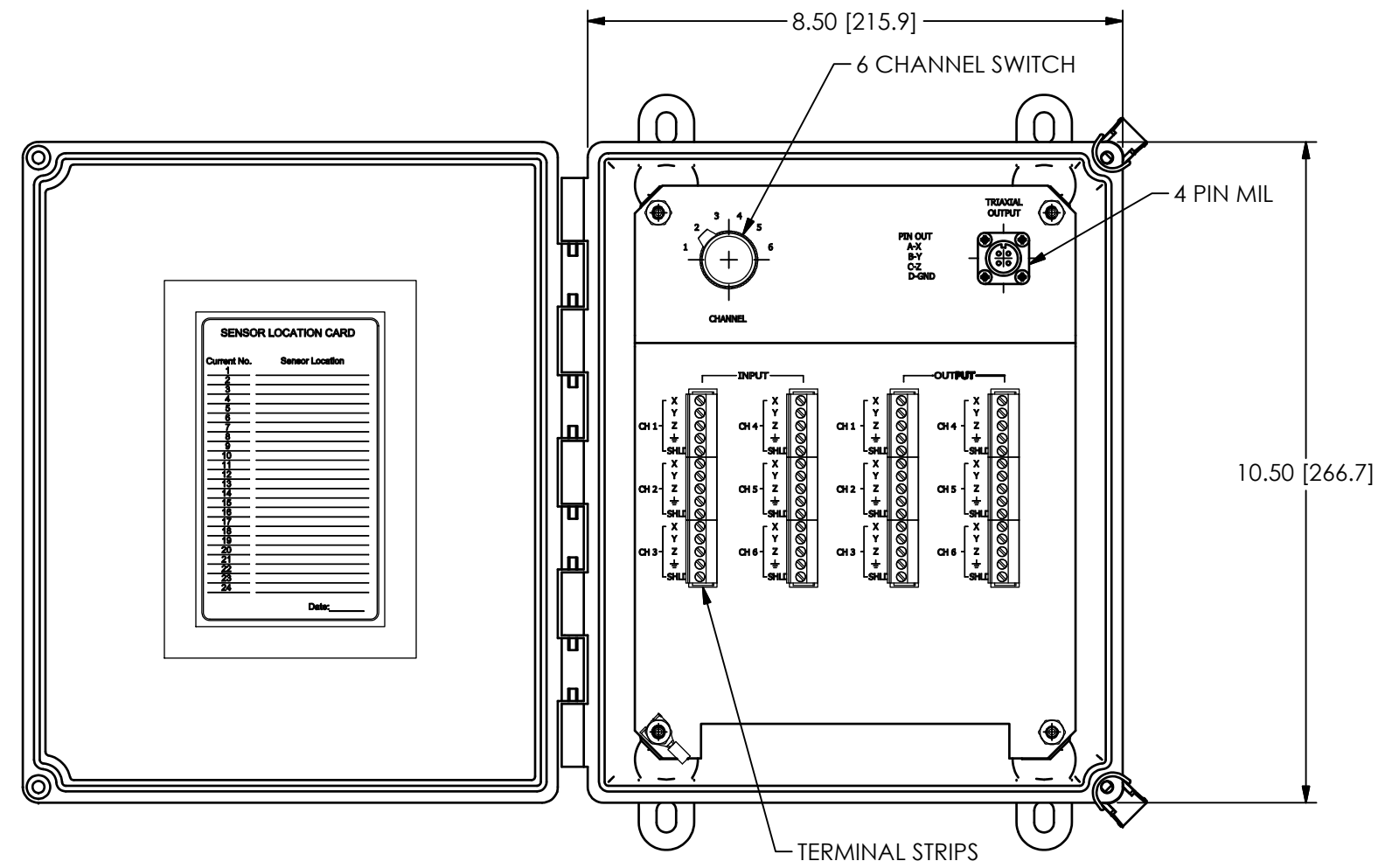

UNLESS OTHERWISE SPECIFIED TOLERANCES ARE:		DRAWN		CHECKED		ENGINEER	
DIMENSIONS IN INCHES	DIMENSIONS IN MILLIMETERS [IN BRACKETS]	JDM	4/10/19	JDM	4/10/19	GGG	4/10/19
DECIMALS XX ±0.03 XXX ±0.10	DECIMALS X ±0.8 XX ±0.25	TITLE OUTLINE DRAWING MODEL 691A84 6 CHANNEL TRIAX SWITCH BOX					
ANGLES ± 2 DEGREES	ANGLES ± 2 DEGREES						
FILLETS AND RADII .003 - .005	FILLETS AND RADII 0.07 - 0.13	CODE IDENT. NO. 52681		DWG. NO. 68794		SCALE: .375X SHEET 1 OF 1	

PCB PIEZOTRONICS
 3425 WALDEN AVE. DEPEW, NY 14043
 (716) 684-0001 E-MAIL: sales@pcb.com