



Model EX623C00

High Frequency Industrial ICP® Accelerometer

Installation and Operating Manual

**For assistance with the operation of this product,
contact PCB Piezotronics, Inc.**

**Toll-free: 800-959-4464
24-hour SensorLine: 716-684-0001
Fax: 716-684-3823
E-mail: imi@pcb.com
Web: www.imi-sensors.com**



Repair and Maintenance

PCB guarantees Total Customer Satisfaction through its “Lifetime Warranty Plus” on all Platinum Stock Products sold by PCB and through its limited warranties on all other PCB Stock, Standard and Special products. Due to the sophisticated nature of our sensors and associated instrumentation, **field servicing and repair is not recommended and, if attempted, will void the factory warranty.**

Beyond routine calibration and battery replacements where applicable, our products require no user maintenance. Clean electrical connectors, housings, and mounting surfaces with solutions and techniques that will not harm the material of construction. Observe caution when using liquids near devices that are not hermetically sealed. Such devices should only be wiped with a dampened cloth—never saturated or submerged.

In the event that equipment becomes damaged or ceases to operate, our Application Engineers are here to support your troubleshooting efforts 24 hours a day, 7 days a week. Call or email with model and serial number as well as a brief description of the problem.

Calibration

Routine calibration of sensors and associated instrumentation is necessary to maintain measurement accuracy. We recommend calibrating on an annual basis, after exposure to any extreme environmental influence, or prior to any critical test.

PCB Piezotronics is an ISO-9001 certified company whose calibration services are accredited by A2LA to ISO/IEC 17025, with full traceability to SI through N.I.S.T. In addition to our standard calibration services, we also offer specialized tests, including: sensitivity at elevated or cryogenic temperatures, phase response, extended high or low frequency response, extended range, leak testing, hydrostatic pressure testing, and others. For more information, contact your local PCB Piezotronics distributor, sales representative, or factory customer service representative.

Returning Equipment

If factory repair is required, our representatives will provide you with a Return Material Authorization (RMA) number, which we use to reference any information you have already provided and expedite the repair process. This number should be clearly marked on the outside of all returned package(s) and on any packing list(s) accompanying the shipment.

Contact Information

PCB Piezotronics, Inc.
3425 Walden Ave.
Depew, NY14043 USA
Toll-free: (800) 828-8840
24-hour SensorLine: (716) 684-0001
General inquiries: info@pcb.com
Repair inquiries: rma@pcb.com

For a complete list of distributors, global offices and sales representatives, visit our website, www.pcb.com.

Safety Considerations

This product is intended for use by qualified personnel who recognize shock hazards and are familiar with the precautions required to avoid injury. While our equipment is designed with user safety in mind, the protection provided by the equipment may be impaired if equipment is used in a manner not specified by this manual.

Discontinue use and contact our 24-Hour Sensorline if:

- Assistance is needed to safely operate equipment
- Damage is visible or suspected
- Equipment fails or malfunctions

For complete equipment ratings, refer to the enclosed specification sheet for your product.

Definition of Terms and Symbols

The following symbols may be used in this manual:



DANGER

Indicates an immediate hazardous situation, which, if not avoided, may result in death or serious injury.

**CAUTION**

Refers to hazards that could damage the instrument.

**NOTE**

Indicates tips, recommendations and important information. The notes simplify processes and contain additional information on particular operating steps.

The following symbols may be found on the equipment described in this manual:



This symbol on the unit indicates that high voltage may be present. Use standard safety precautions to avoid personal contact with this voltage.



This symbol on the unit indicates that the user should refer to the operating instructions located in the manual.



This symbol indicates safety, earth ground.



PCB工业监视和测量设备 - 中国RoHS2公布表

PCB Industrial Monitoring and Measuring Equipment - China RoHS 2 Disclosure Table

部件名称	有害物质					
	铅 (Pb)	汞 (Hg)	镉 (Cd)	六价铬 (Cr(VI))	多溴联苯 (PBB)	多溴二苯醚 (PBDE)
住房	0	0	0	0	0	0
PCB板	X	0	0	0	0	0
电气连接器	0	0	0	0	0	0
压电晶体	X	0	0	0	0	0
环氧	0	0	0	0	0	0
铁氟龙	0	0	0	0	0	0
电子	0	0	0	0	0	0
厚膜基板	0	0	X	0	0	0
电线	0	0	0	0	0	0
电缆	X	0	0	0	0	0
塑料	0	0	0	0	0	0
焊接	X	0	0	0	0	0
铜合金/黄铜	X	0	0	0	0	0
本表格依据 SJ/T 11364 的规定编制。						
0：表示该有害物质在该部件所有均质材料中的含量均在 GB/T 26572 规定的限量要求以下。						
X：表示该有害物质至少在该部件的某一均质材料中的含量超出 GB/T 26572 规定的限量要求。						
铅是欧洲RoHS指令2011/65/ EU附件三和附件四目前由于允许的豁免。						

CHINA RoHS COMPLIANCE

Component Name	Hazardous Substances					
	Lead (Pb)	Mercury (Hg)	Cadmium (Cd)	Chromium VI Compounds (Cr(VI))	Polybrominated Biphenyls (PBB)	Polybrominated Diphenyl Ethers (PBDE)
Housing	O	O	O	O	O	O
PCB Board	X	O	O	O	O	O
Electrical Connectors	O	O	O	O	O	O
Piezoelectric Crystals	X	O	O	O	O	O
Epoxy	O	O	O	O	O	O
Teflon	O	O	O	O	O	O
Electronics	O	O	O	O	O	O
Thick Film Substrate	O	O	X	O	O	O
Wires	O	O	O	O	O	O
Cables	X	O	O	O	O	O
Plastic	O	O	O	O	O	O
Solder	X	O	O	O	O	O
Copper Alloy/Brass	X	O	O	O	O	O

This table is prepared in accordance with the provisions of SJ/T 11364.

O: Indicates that said hazardous substance contained in all of the homogeneous materials for this part is below the limit requirement of GB/T 26572.

X: Indicates that said hazardous substance contained in at least one of the homogeneous materials for this part is above the limit requirement of GB/T 26572.

Lead is present due to allowed exemption in Annex III or Annex IV of the European RoHS Directive 2011/65/EU.



INDUSTRIAL MONITORING INSTRUMENTATION DIVISION

Piezoelectric ICP® Accelerometers Operating Guide

Operating Guide with Enclosed Warranty Information

3424 Walden Avenue, Depew, New York 14043-2495

Phone (716) 684-0003

Fax (716) 684-3823

Toll Free Line 1-800-959-4IMI

***MANUAL NUMBER: 18405
MANUAL REVISION: A***

ECN NUMBER: 49766

General
OPERATING GUIDE

for use with

PIEZOELECTRIC ICP® ACCELEROMETERS

SPECIFICATION SHEET, INSTALLATION DRAWING AND CALIBRATION INFORMATION ENCLOSED

IMI ASSUMES NO RESPONSIBILITY FOR DAMAGE CAUSED TO THIS PRODUCT AS A RESULT OF PROCEDURES THAT ARE INCONSISTENT WITH THIS OPERATING GUIDE

1.0 INTRODUCTION

Congratulations on the purchase of a quality ICP® industrial sensor. In order to ensure the highest level of performance for this product, it is imperative that you properly familiarize yourself with the correct mounting and installation techniques before attempting to operate this device. If, after reading this manual, you have any additional questions concerning this sensor or its application, feel free to call an Application Engineer at **716-684-0003** or **800-959-4464**.

Proper sensor selection requires special attention to three main areas: sensor design, dynamic expectations, and application environment.

Sensor design encompasses the actual sensing element, the physical material, and component selection for the sensor. Preferred industrial accelerometers employ a shear sensing element with either a quartz or ceramic crystal.

Quartz sensing elements are typically used when long-term stability and minimum output shifts due to temperature changes are desired. Ceramic sensing elements provide excellent resolution and durability in noisy environments, and can be designed to supply low-frequency and high-frequency measurements. Shear-design sensors are preferred because of their inherent insensitivity to adverse environmental influences, such as case or base strain and thermal transients. Internal case isolation and shielding is important in avoiding erroneous signals resulting from ground loops and pick-up of electromagnetic and radio frequency interference. Other critical material selection criteria include non-magnetic stainless steel housing, hermetic sealing, and industrial military connectors. See Figure 1.

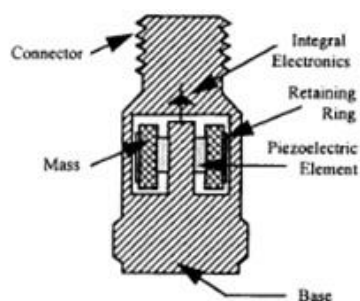

Figure 1. Typical Industrial Shear Mode Accelerometer

Dynamic expectations are application-specific and refer to the frequency range of measurement and the anticipated amplitudes of vibration. After careful review of the machinery to be monitored, minimum and maximum measurement frequency ranges may be established. The minimum measurement frequency is normally related to any sub-harmonics of running speed or any lower frequencies where vibration data is to be collected. The maximum measurement frequency of interest is determined by the maximum number of harmonics of an event like running speed, bearing frequencies, or gear mesh. This measurement frequency range should be well within the specified frequency range of the sensor.

Amplitude range refers to the anticipated levels of vibration to be measured. These values are related to the alarm levels set for the machine. By carefully evaluating the idiosyncrasies of the machinery, the predictive maintenance engineer can estimate the minimum expected vibration levels and ensure that the electrical noise floor of the accelerometer is less than those levels.

The environment of the application is a critical consideration during program implementation. The sensor chosen must be capable of surviving the wide range of conditions to which it is subjected; therefore, take time to evaluate potential conditions, such as high temperatures and chemical contaminants. The specified temperature range of the sensor must conform to the fluctuations of the environmental temperature. If harsh industrial chemicals are present, the sensor requires hermetic sealing and construction that resists corrosion. Finally, specific location of the sensor within the environment must be sensible, as both cable and sensor may be damaged by imprudent installation in heavily traveled, physically punishing areas.

2.0 ICP® ACCELEROMETERS

Enclosed in the back of this guide is a Specification Sheet, which lists the complete performance characteristics of the particular sensor.

All ICP® sensors require a constant current power source for proper operation. A typical sensing system includes an ICP® sensor, ordinary two conductor cable and a basic constant current power supply (as shown in Figure 2).

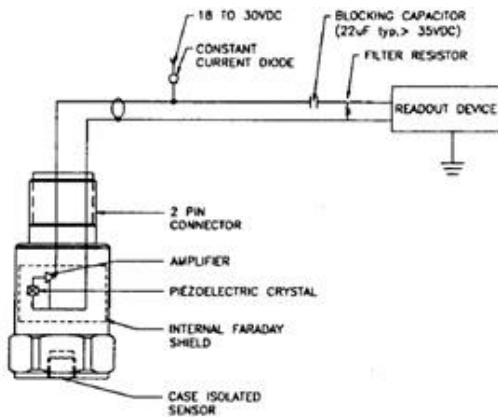

Figure 2. Typical Sensor System

The signal conditioner consists of a well-regulated 18 to 30 VDC source (battery or line-powered), a current-regulating diode (or equivalent constant current circuit), and a capacitor for decoupling (removing the bias voltage) the signal.

The current-regulating device is used in place of a resistor for several reasons. The very high dynamic resistance of the diode yields a source follower gain which is extremely close to unity and independent of

input voltage. Also, the diode can be changed to supply higher currents for driving long cable lengths. Constant current diodes, as shown in Figure 3, should be used in ICP® signal conditioners. **(The correct orientation of the diode within the circuit is critical for proper operation.)** Except for special models, standard ICP® sensors require a minimum of 2 mA for proper operation.

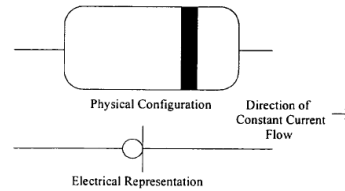

Figure 3. Constant Current Diode

The typical limits for this type of diode are to a 4 mA maximum rating; however, several diodes can be placed in parallel for higher current levels. All line-powered signal conditioners should use higher capacity (up to 20 mA) constant current circuits in place of the diodes, particularly when driving long signal cables (see Section 5).

Decoupling of the data signal occurs at the output stage of the signal conditioner. A 10 to 30 µF capacitor coupled with a resistor shifts the signal level to essentially eliminate the sensor bias voltage. The result is a drift-free AC mode of operation.

3.0 OPTIONAL FEATURES

In addition to standard features, a variety of options are also available. When listed before the model number, the following prefix letters indicate that the sensor is manufactured or supplied with optional features:

- CS - Canadian Standards Association Approved Sensor
- D - Dummy, non-working sensor for display purposes
- EX - Cenelec Approved Sensor
- FM - Factory Mutual Approval Sensor
- HT - High temperature accelerometer (325 °F)
- LB - Low Bias electronics
- LC - Limited Calibration (one point calibration)
- LP - Low Pass filter
- M - Metric mounting hardware and cable length
- U - Usable demonstration sensor (does not meet one or more minor specifications)
- VO - Velocity Output Sensors

MS – Mine Safety Approved Sensors
 TO – Temperature Output Sensor

Note: *Not all sensors are available with the optional prefixes. Contact the factory to discuss special features that may be needed.*

4.0 INSTALLATION OVERVIEW

When choosing a mounting method, consider closely both the advantages and disadvantages of each technique. Characteristics like location, ruggedness, amplitude range, accessibility, temperature, and portability are extremely critical. However, the most important and often overlooked consideration is the effect the mounting technique has on the high-frequency operating range of the accelerometer.

Shown in Figure 4 are six possible mounting techniques and their effects on the performance of a typical piezoelectric accelerometer. (**Note:** *Not all of the mounting methods may apply to your particular sensor.*) The mounting configurations and corresponding graph demonstrate how the high-frequency response of the accelerometer may be compromised as mass is added to the system and/or the mounting stiffness is reduced.

Note: *The low-frequency response is unaffected by the mounting technique. This roll-off behavior is typically fixed by the sensor's built-in electronics. However, when operating AC-coupled signal conditioners with readout devices having an input impedance of less than one megaohm, the low frequency range may be affected.*

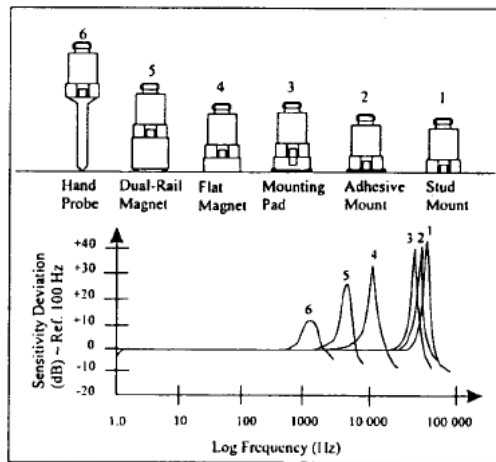
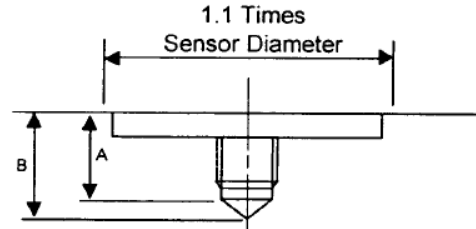

Figure 4. Assorted Mounting Configurations and Their Effects on High Frequency

4.1 STANDARD STUD MOUNT

This mounting technique requires smooth, flat contact surfaces for proper operation and is recommended for permanent and/or secure installations. Stud mounting is also recommended when testing at high frequencies.

Note: *Do NOT attempt mounting on curved, rough, or uneven surfaces, as the potential for misalignment and limited contact surface may significantly reduce the sensor's upper operating frequency range.*



	1/4-28 Stud	1/4-28 Captive Screw
A (in.)	.250	.250
B (in.)	.350	.350
Torque (ft-lb)	2 to 5	2 to 5

Figure 5. Mounting Surface Preparation

STEP 1: First, prepare a smooth, flat mounting surface and then drill and tap a mounting hole in the center of this area as shown in Figure 5.

A precision-machined mounting surface with a minimum finish of 63 μin (0.0016 mm) is recommended. (If it is not possible to properly prepare the machine surface, consider using an adhesive mounting pad as a possible alternative.) Inspect the area, checking that there are no burrs or other foreign particles interfering with the contact surface.

STEP 2: Wipe clean the mounting surface and spread on a light film of grease, oil, or similar coupling fluid prior to installation. See Figure 6.

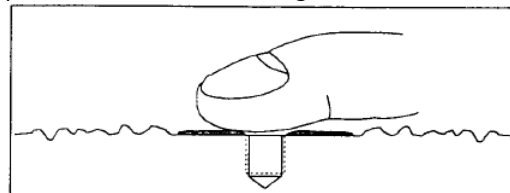

Figure 6. Mounting Surface Lubrication

Adding a coupling fluid improves vibration transmissibility by filling small voids in the mounting surface and increasing the mounting stiffness. For

semi-permanent mounting, substitute epoxy or another type of adhesive.

STEP 3: Hand-tighten the sensor/mounting stud to the machine, then secure the sensor with a torque wrench to the mounting surface by applying the recommended mounting torque. (See enclosed specification data sheet for proper mounting torque.)

It is important to use a torque wrench during this step. Under-torqueing the sensor may not adequately couple the device; over-torqueing may result in stud failure and possibly permanent damage.

4.2 ADHESIVE MOUNT

Adhesive mounting is often used for temporary installation or when the machine surface cannot be adequately prepared for stud mounting. Adhesives like hot glue or wax work well for temporary mounts; two-part epoxies and quick-bonding gels provide a more permanent mount.

Note: *Adhesively-mounted sensors often exhibit a reduction in high-frequency range. Generally, smooth surfaces and stiff adhesives provide the best frequency response. Contact the factory for recommended epoxies.*

METHOD 1 – Adhesive mounting base

This method involves attaching a base to the machine surface, then securing the sensor to the base. This allows for easy removal of the accelerometer.

STEP 1: Prepare a smooth, flat mounting surface. A minimum surface finish of 63 μin (0.0016 mm) generally works best.

STEP 2: Stud-mount the sensor to the appropriate adhesive mounting base according to the guidelines set forth in **STEPS 2** and **3** of the Stud Mount Procedure.

STEP 3: Place a small portion of adhesive on the underside of the mounting base. Firmly press down on the assembly to displace any extra adhesive remaining under the base. See Figure 7.

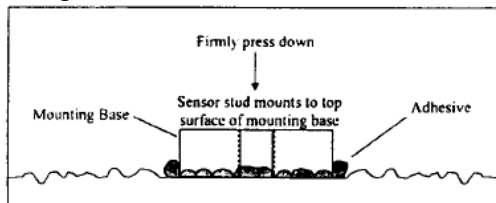

Figure 7. Mounting Base: Adhesive Installation

METHOD 2 – Direct Adhesive Mount

For restrictions of space or for convenience, most sensors (with the exception of integral stud models) can be adhesive-mounted directly to the machine surface.

STEP 1: Prepare a smooth, flat mounting surface. A minimum surface finish of 63 μin (0.0016 mm) generally works best.

STEP 2: Place a small portion of adhesive on the underside of the sensor. Firmly press down on the top of the assembly to displace any adhesive. Be aware that excessive amounts of adhesive can make sensor removal difficult. See Figure 8.

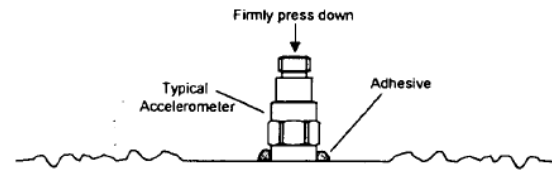

Figure 8. Direct Adhesive Mounting

4.3 MAGNETIC MOUNT

Magnetic mounting provides a convenient means for making portable measurements and is commonly used for machinery monitoring and other portable or trending applications.

Note: *The correct magnet choice and an adequately prepared mounting surface are critical for obtaining reliable measurements, especially at high frequencies. Poor installations can cause as much as a 50% drop in the sensor frequency range.*

Not every magnet is suitable for all applications. For example, rare earth magnets are commonly used because of their high strength. Flat magnets work well on smooth, flat surfaces, while dual-rail magnets are required for curved surfaces. In the case of non-magnetic or rough surfaces, it is recommended that the user first weld, epoxy, or otherwise adhere a steel mounting pad to the test surface. This provides a smooth and repeatable location for mounting.

STEP 1: After choosing the correct magnet type, inspect the unit, verifying that the mounting surfaces are flat and smooth. See Figure 9.

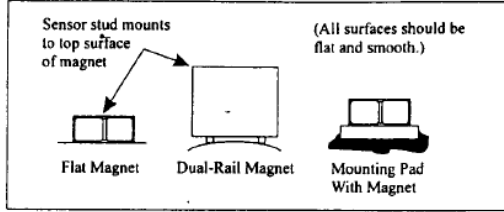

Figure 9. Magnet Types

STEP 2: Stud-mount the accelerometer to the appropriate magnet according to the guidelines set forth in **STEPS 2** and **3** of the Stud Mount Procedure.

STEP 3: Prepare a smooth, flat mounting surface. A minimum surface finish of 63 μin (0.0016 mm) generally works best. After cleaning the surface and checking for burrs, wipe on a light film of silicone grease, machine oil, or similar-type coupling fluid.

STEP 4: Mount the magnet/sensor assembly to the prepared test surface by gently “rocking” or “sliding” it into place. See Figure 10.

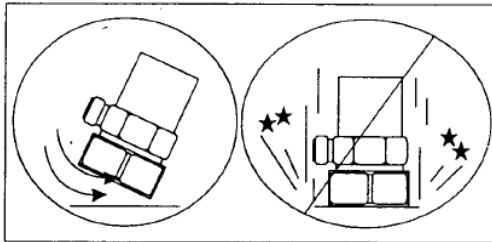

Figure 10. Magnet Mounting

Note: *Magnetically mounting accelerometers carelessly has the potential to generate very high (and very damaging) g levels. To prevent damage, install the assembly gently. If unsure, please contact the factory for assistance.*

4.4 HANDHELD OR PROBE TIP MOUNT

This method is NOT recommended for most applications. It is generally used where access to machinery may be a safety concern. Both the accuracy and repeatability at low (<5 Hz) and high frequency (>1 kHz) ranges are questionable.

5.0 CABLING

The selection of connectors and cables has a direct impact on the ruggedness and reliability of the sensor installation. A consideration when dealing with cables is the way in which the cable conductors are terminated.

ICP® accelerometers are internally amplified, two-wire accelerometers. Connections to the sensor require two leads: one for the power and signal, and the other for the common and signal return. Often, coaxial cables are used since only two conductors are needed. Coaxial cables are less expensive. With coaxial cables, however, erroneous signals can be introduced into sensor systems through ground loops, electromagnetic interference, or radio frequency interference (EMI or RFI). To avoid ground loops, there should only be one ground in the system.

It is recommended for permanent installations that the sensor be case-isolated and internally shielded with a dual-case design and use a two-conductor shielded cable to insure clean vibration signal transmission. Two-conductor shielded cables allow the signal and the signal return (common) to be fully shielded from the sensor to the readout equipment. To insure that ground loop signals are not induced, the shield should only be terminated at one end. Typically, the shield of a two-conductor shielded cable is left open or not connected at the sensor end and is tied to earth ground at the instrumentation end.

Operation over long cables may affect the frequency response of ICP® accelerometers, and introduce low frequency noise and high frequency distortion when an insufficient current is available to drive cable capacitance.

Unlike charge mode systems, where the system noise is a function of cable length, ICP® sensors provide a high voltage, low impedance output well-suited for driving long cables through harsh environments. While there is virtually no increase in noise with ICP® sensors, the capacitive loading of the longer cable may be distort or filter higher frequency signals depending on the supply current and the output impedance of the sensor.

Generally, this signal distortion is not a problem with lower frequency testing within a range up to 1,000 Hz. However, when monitoring higher frequency vibrations traveling over cables longer than 500ft, the possibility of signal distortion exists.

The maximum frequency that can be transmitted over a given cable length is a function of both the cable capacitance and the ratio of the peak signal voltage to the current available from the signal conditioner according to:



$$f_{\max} = \frac{10^9}{2\pi CV} \quad (\text{Equation 1})$$

[L_c-1]

- Where, f_{max} = maximum frequency (hertz)
C = cable capacitance (picofarads)
V = maximum peak output from sensor (volts)
L_c = constant current from signal conditioner (mA)
10⁹ = scaling factor to equate units

Note that in this equation, 1 mA is subtracted from the total current supplied to sensor (L_c). This is done to compensate for powering the internal electronics. Also, note that these are typical values only.

When driving long cables, Equation 1 shows that, as the length of the cable, peak voltage output or maximum frequency of interest increases, a greater constant current will be required to drive the signal.

The nomograph on page 12 of this manual provides a simple, graphical method for obtaining the expected maximum frequency capability of an ICP® measurement system. The maximum peak signal voltage amplitude, cable capacitance and supplied constant current must be known or presumed.

For example, when running at 100 ft (30.5 m) cable with a capacitance of 30 pF/ft, the total capacitance is 3,000pF. This value can be found along the diagonal cable capacitance lines. Assuming the sensor operates at a maximum output range of 5 volts and the constant current available from the power supply is 2 mA, the ratio on the vertical axis can be calculated to equal 5. The intersection of the total cable capacitance and this ratio result in a maximum frequency of approximately 10.2 kHz.

The nomograph does not indicate whether the frequency amplitude response at a point is flat, rising or falling. For precautionary reasons, it is good general practice to increase the constant current (if possible) to the sensor (within its maximum limit) so that the frequency determined from the nomograph is approximately 1.5 to 2 times greater than the maximum frequency of interest.

Note: Higher current levels will deplete battery-powered signal conditioners at a faster rate. Also, any current not used by the cable goes directly to power the internal electronics and will create heat. This may cause the sensor to

exceed its maximum temperature specification. For this reason, do not supply excessive current over short cable runs or when testing at elevated temperatures.

5.1 CABLE CONNECTOR PROCEDURE

Care and attention to installation is essential, as the reliability and accuracy of your system is no better than that of the output cable.

STEP 1: Ascertain that you have ordered the correct cable type.

As with sensors, no cable can satisfy all applications. Special low-noise cabling should be used with high impedance, charge-output devices. ICP® sensors usually operate with any ordinary tow-wire cable. Industrial applications often require twisted/shielded cables to reduce the effects of EMI and RFI. PTFE-jacketed cabling may be necessary to withstand corrosive environments.

STEP 2: Connect the cable to the accelerometer. A small amount of thread-locking compound placed on the connector prior to attachment helps secure the cable during testing. In harsh environments, the connection can be sealed with silicone rubber, O-rings, and flexible heat-shrink tubing.

STEP 3: Plug the connector of the cable into the mating sensor connector. Then, holding the sensor stationary, secure the connector in place by tightening down the attached threaded cable sleeve.

STEP 4: Route the cable to the signal conditioner, making certain to stress-relieve the sensor/cable connection and minimize motion by clamping the cable at regular intervals.

Common sense should be used to avoid physical damage and minimize electrical noise. For instance, avoid routing cables near high-voltage wires. Do not route cables along floors or walkways where they be stepped on or become contaminated. Shielded cables should have the shield grounded at one end only, normally at the instrumentation end.

STEP 5: Finally, connect the remaining cable end to the signal conditioner or readout device. To dissipate charge that may have accumulated in the cable short the signal to ground prior to attachment.

6.0 POWERING

All ICP® sensors require constant current excitation for proper operation. For this reason only use approved constant-current sources. A typical system schematic is shown in Figure 11.

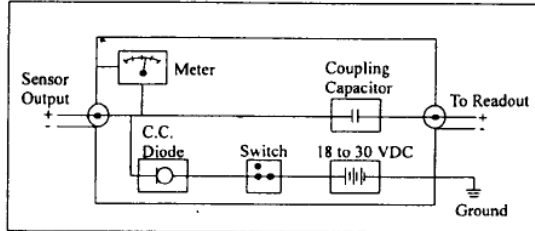

Figure 11. Typical System Schematic

The power supply consists of a regulated 18 to 30 VDC source. In general, battery-powered devices offer versatility for portable, low-noise measurements, whereas line-powered units provide the capability for continuous monitoring. This power is regulated by a current-limiting circuit, which provides the constant-current excitation required for proper operation of sensors with integral electronics.

Note: Under no circumstances should a voltage be supplied to an ICP® accelerometer without a current-regulating diode or equivalent electrical circuit.

A capacitor at the output stage of the device removes the sensor output bias voltage from the measurement signal. This provides a zero-based, AC-coupled output compatible with most standard readout devices.

Today, many FFT analyzers, data acquisition modules, and data collectors have constant-current excitation for direct use with ICP® sensors. However, before using this feature, check that the supply voltage and constant current are adequate for use with your sensor. Please contact the respective signal conditioner manufacturer or check the product manual for more information.

7.0 OPERATING

After completing the system setup, switch on the conditioner, the meter (or LED) and allow the sensor to power up. If a faulty condition is monitored, first check all system connections, then check the functionality of the cable and signal conditioner. If

the system still does not operate properly, consult an IMI Application Engineer.

Note: Always operate the accelerometer within the limitations listed on the Specification Sheet of your sensor. Operating the device outside of its parameters can cause temporary or permanent damage to the sensor.

8.0 ACCELEROMETER CALIBRATION

Note: It is good measurement practice to verify the performance of each accelerometer before and after each measurement.

Accelerometers are precision measuring instruments. They are highly engineered to provide accurate electrical signals representative of the vibration being monitored. Each sensor is calibrated by comparison to a known acceleration level. Some calibrations include frequency response curves, resonant frequency measurements, transvers sensitivity, and many other valuable tests. Applications requiring a high degree of accuracy or those in plants requiring certification and traceability require full calibration test results.

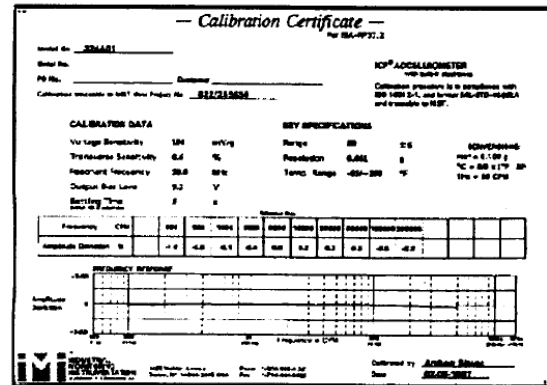

Figure 12. Typical Calibration Certificate

Some applications have much less stringent requirements for calibration certification. Simple sensitivity measurements at a single frequency may be sufficient; operational verification and certificates of conformance to published specifications may satisfy many plants' calibration needs. Reducing the final calibration requirements reduces the cost of manufacturing the sensor and should lower the price for predictive maintenance users.

Periodic recalibration may be required by plants with strict certification and traceability requirements. It is always recommended that the user has the sensor recalibrated periodically, particularly if the sensor has experienced a very high shock level or extreme temperatures for extended periods of time. Some plants develop in-house calibration capabilities for periodically verifying the performance of accelerometers. Products are available that provide a set 1 g-acceleration level at a fixed frequency for quick sensor checking.

For these reasons, it is recommended that a recalibration cycle be established for each accelerometer. This schedule is unique and is based on a variety of factors, such as extent of use, environmental conditions, accuracy requirements, trend information obtained from previous calibration records, contractual regulations, frequency of “cross-checking” against other equipment, manufacturer recommendation, and any risk associated with incorrect readings. International standards, such as ISO 10012-1, provide insight and suggested methods for determining recalibration intervals for most measuring equipment. With the above information in mind and under “normal” circumstances, a conservative suggestion of 12 to 24 month recalibration cycle for most piezoelectric accelerometers is advised.

8.1 SENSOR CALIBRATION

Accelerometer recalibration services are typically performed by IMI’s internal metrology laboratory. (Other international and private laboratories are also available.) The IMI laboratory is certified to ISO 9001, complies with ISO 10012-1 (and former MIL-STD-45662A), and uses equipment directly traceable to NIST. This assures an accurate calibration of relevant specifications.

The following includes a broad overview of the Back-to-Back Calibration technique normally used when calibrating accelerometers. This technique provides a quick and easy method for determining the sensitivity of a test accelerometer over a wide frequency range.

8.2 BACK-TO-BACK CALIBRATION THEORY

Back-to-back calibration is perhaps the most common method for determining the sensitivity of

piezoelectric accelerometers. This method relies on a simple comparison to a previously calibrated accelerometer, typically referred to as a reference standard, as shown in Figure 12.

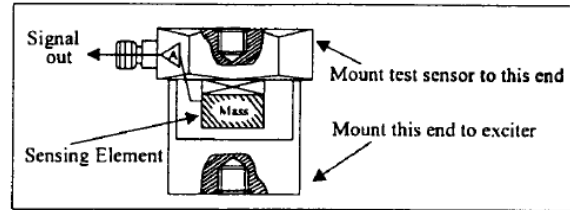

Figure 12. Reference Standard Accelerometer

These high-accuracy devices, which are directly traceable to a recognized standards laboratory, are designed for stability, as well as configured to accept a test accelerometer. By mounting a test accelerometer to the reference standard and then connecting this combination to a suitable vibration source, it is possible to vibrate both devices and compare the data as shown in Figure 13. (Test setups may be automated and vary, depending on the type and number for accelerometers being calibrated.)

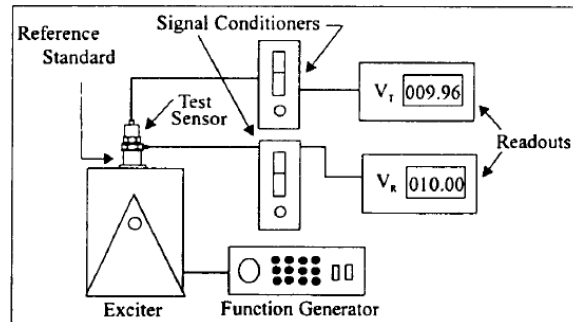

Figure 13. Typical Back-to-Back Calibration System

Because the acceleration is the same on both sensors, the ratio of their outputs (V_T/V_R) must also be the ratio of their sensitivities. With the sensitivity of the reference standard (S_R) known, the exact sensitivity of the test sensor (S_T) is easily calculated by using the following equation:

$$S_T = S_R \left(\frac{V_T}{V_R} \right)$$

By varying the frequency of the vibration, the sensor may be calibrated over its entire operating frequency range. The typical response of an unfiltered accelerometer is shown in Figure 14.

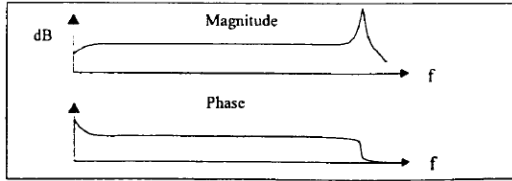

Figure 14. Typical Test Accelerometer Response

9.0 TROUBLESHOOTING

Piezoelectric sensors are dynamic measuring equipment. They use piezoelectric sensing elements to convert or transduce the mechanical phenomena to an electrical signal. The mechanical parameter may be force, pressure or vibration. The raw electrical signal from a piezoelectric charge element is a high impedance signal. This charge signal is normally converted to a low impedance voltage signal by either an external charge amplifier or an external voltage amplifier. The cables between the charge sensor and the amplifier must be high quality, low noise cable and must be kept as short as possible. Figure 15 shows a typical high impedance system.

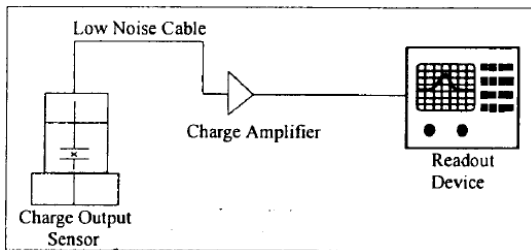

Figure 15. High Impedance System Connection

Internally amplified sensors employ miniature amplifiers to convert the high impedance charge signal into a low impedance voltage signal. These amplifiers are internal to the sensor, and therefore, do not require low noise cables or external amplifiers. These amplifiers have set gain so that output sensitivities are standardized.

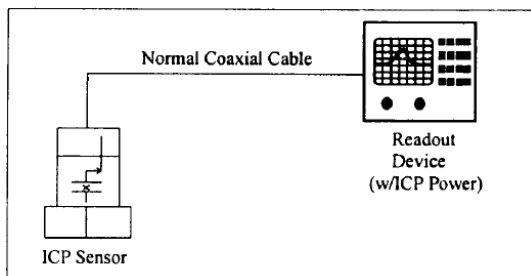

Figure 16. Sensor with Integral Electronics System Connector

ICP® sensors are two-wire sensors. They are powered with a constant current DC source. The power supply is typically 18 to 30 volts DC current limited via a constant current between 2 and 20 mA. Typical battery operated supplies offer 2mA of constant current to extend battery life while continuous monitoring systems offer more current in order to drive longer cables. Figure 16 shows a typical system for a sensor with integral electronics.

The signal output of a sensor with integral electronics is a low impedance voltage signal proportional to the dynamic measurement such as force, pressure, or vibration. This voltage signal is carried on a DC bias voltage. The AC dynamic signal is superimposed on the DC bias voltage and is allowed to swing between the supply voltage and ground as shown in Figure 17. Unlike an operational amplifier that requires a plus and minus supply and allows the signal to “ride” on ground and “swing” between the plus and minus “rails,” the sensor with integral electronics requires the output signal to be DC biased.

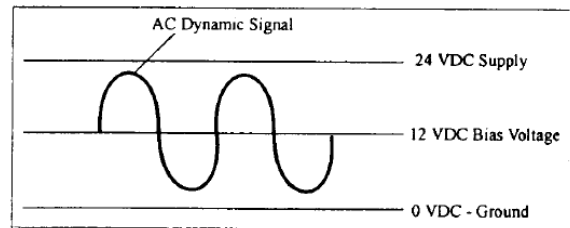

Figure 17. Sensor DC Bias Voltage

This DC bias voltage is an excellent diagnostic tool. The voltage provides a means of verifying that the amplifier is “turned on.” Typical input/output power supplies will block this DC bias voltage at the output via a blocking capacitor in order to AC couple the signal to readout devices. By “teeing” off the input into a DC volt meter, as shown in Figure 18, the bias voltage can be measured.

While measuring the supply voltage, the bias voltage can be measured after the sensor is plugged in. If the meter stays at supply, something in the system is open or not connected. If the meter reads “0,” something in the system is shorted. If the meter reads within the bias voltage range of the sensor, then the sensor and cabling are functioning properly.

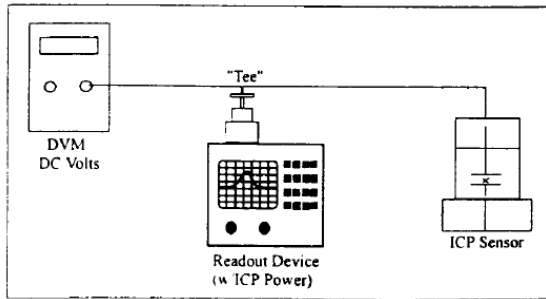

Figure 18. DC Bias Voltage Measurement

10.0 REPAIR/RETURN PROCEDURE

Because of the nature of most IMI instrumentation, field repair is typically NOT recommended and may void any warranty. If factory service is required, contact IMI for a **RETURN MATERIAL AUTHORIZATION (RMA)** number prior to sending equipment to the factory. Please have information available, such as model and serial number. Also, to insure efficient service, be sure to include a written description of the symptoms and problems with the equipment to a local sales representative or distributor, or contact IMI if none are located in your area.

Customers outside the U.S. should consult their local IMI distributor for information on returning equipment. For exceptions, please contact the International Sales department at IMI to request shipping instructions and an

RMA. For assistance, please call **(716) 684-0003**, or fax us at **(716) 684-3823**. You may also receive assistance via e-mail at imi@pcb.com or visit our website at www.pcb.com.

11.0 CUSTOMER SERVICE/WARRANTY

IMI, a division of PCB Piezotronics, guarantees **Total Customer Satisfaction**. If, at any time, for any reason, you are not completely satisfied with any IMI product, IMI will repair, replace or exchange it at no charge. You may also choose to have your purchase price refunded.

IMI instrumentation is warranted against defective material workmanship for 1 year unless otherwise expressly specified. Damage to instruments caused by incorrect power or misapplication, is not covered by warranty. *If there are any questions regarding power, intended application, or general usage, please consult with your local sales contact or distributor.* Batteries or expendable hardware items are not covered by warranty.

IMI offers to all customers, at no charge, 24-hour phone support. This service makes product or application support available to our customers, day or night, seven days a week. When unforeseen problems or emergency situations arise, call the **IMI Hot Line at (716) 684-0003**, and an application specialist will assist you.

Cable Driving Nomograph

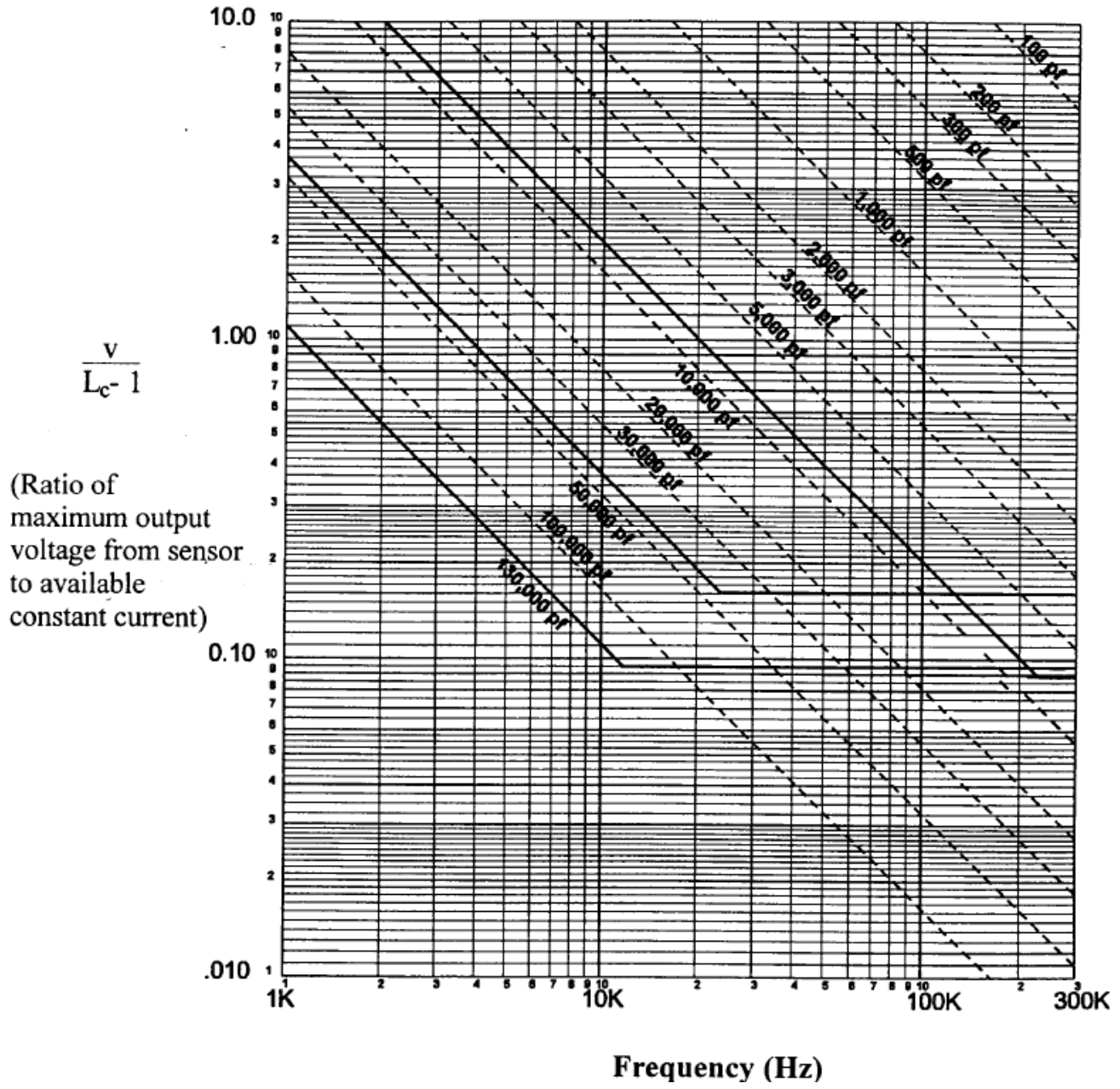

INDUSTRIAL ICP® ACCELEROMETER

Revision: D
ECN #: 29661

Model Number
623C00

Performance
Sensitivity(± 5 %) 1.0 mV/(m/s²) [2]
Measurement Range ± 4905 m/s² [3]
Frequency Range(± 5 %) 2.4 to 8000 Hz
Frequency Range(± 10 %) 1.7 to 10,000 Hz
Frequency Range(± 3 dB) 0.8 to 15,000 Hz
Resonant Frequency 40 kHz [1]
Broadband Resolution(1 to 10,000 Hz) 2943 µm/s² [1]
Non-Linearity ± 1 % [4]
Transverse Sensitivity ≤ 5 %
Environmental
Overload Limit(Shock) 49,050 m/s² pk
Temperature Range -54 to +121 °C [1]
Temperature Response See Graph
Enclosure Rating IP68

Electrical
Settling Time(within 1% of bias) ≤ 3.0 sec
Discharge Time Constant ≥ 0.2 sec
Excitation Voltage 18 to 28 VDC
Constant Current Excitation 2 to 20 mA
Output Impedance <100 ohm
Output Bias Voltage 8 to 12 VDC
Spectral Noise(10 Hz) 117 (µm/s²)/√Hz [1]
Spectral Noise(100 Hz) 44 (µm/s²)/√Hz [1]
Spectral Noise(1 kHz) 26.5 (µm/s²)/√Hz [1]
Electrical Protection RFI/ESD
Electrical Isolation(Case) >10⁸ ohm

Physical
Size (Hex x Height) 11/16 in x 1.97 in
Weight 1.80 oz
Mounting Thread 1/4-28 Female
Mounting Torque 2 to 5 ft-lb
Sensing Element Ceramic
Sensing Geometry Shear
Housing Material Stainless Steel
Sealing Welded Hermetic
Electrical Connector 2-Pin MIL-C-5015
Electrical Connection Position Top

OPTIONAL VERSIONS
Optional versions have identical specifications and accessories as listed for the standard model except where noted below. More than one option may be used.
CS - Canadian Standards Association Approved Intrinsically Safe Hazardous Area Approval CI I, Div 1, Groups A, B, C, D; CI II, Div 1, Groups E, F, G; CI III, II, Div 1, Groups E, F, G; CI III, Div 1
Hazardous Area Approval Exia IIC T4, AExia IIC, T4 Exia IIC T4, AExia IIC, T4
Hazardous Area Approval CI I, Div 2, Groups A, B, C, D; ExnL IIC T4, AExnA IIC T4
EX - ATEX, CSA, or ATEX and CSA Hazardous Area Approval Hazardous Area Approval EEEx ia IIC T4, -54°C≤Tas121° EEEx ia IIC T4, -54°C≤Tas121° C, II 1 G
LB - Low Bias Voltage Output Bias Voltage 6 to 8 VDC
Excitation Voltage 12 to 28 VDC
Measurement Range ± 350 g
M - Metric Mount Supplied Accessory : Model M081A61 Mounting Stud 1/4-28 to M6 X 1 (1) replaces Model 081A40

NOTES:
[1] Typical.
[2] Conversion Factor 1g = 9.81 m/s².
[3] The high frequency tolerance is accurate within ±10% of the specified frequency.
[4] Zero-based, least-squares, straight line method.
[5] 1/4-28 has no equivalent in S.I. units.
[6] See PCB Declaration of Conformance PS023 or PS061 for details.

SUPPLIED ACCESSORIES:
Model 081A40 Mounting Stud (1)
Model ICS-1 NIST-traceable single-axis amplitude response calibration from 600 cpm (10 Hz) to upper 5% frequency

ENGLISH
10 mV/g
± 500 g
144 to 480,000 cpm
102 to 600,000 cpm
48 to 900,000 cpm
2400 kcpm
300 µg
± 1 %
≤ 5 %
5000 g pk
-65 to +250 °F
See Graph
IP68

SI
1.0 mV/(m/s²)
± 4905 m/s²
2.4 to 8000 Hz
1.7 to 10,000 Hz
0.8 to 15,000 Hz
40 kHz
2943 µm/s²
± 1 %
≤ 5 %
49,050 m/s² pk
-54 to +121 °C
See Graph
IP68

≤ 3.0 sec
≥ 0.2 sec
18 to 28 VDC
2 to 20 mA
<100 ohm
8 to 12 VDC
117 (µm/s²)/√Hz
44 (µm/s²)/√Hz
26.5 (µm/s²)/√Hz
RFI/ESD
>10⁸ ohm

11/16 in x 1.97 in
1.80 oz
1/4-28 Female
2 to 5 ft-lb
Ceramic
Shear
Stainless Steel
Welded Hermetic
2-Pin MIL-C-5015
Top

17.5 mm x 50 mm
51 gm
Not Applicable
2.7 to 6.8 N-m
Ceramic
Shear
Stainless Steel
Welded Hermetic
2-Pin MIL-C-5015
Top

Typical Sensitivity Deviation vs Temperature

Sensitivity Deviation(%)

Temperature (°F)

CE [6]

Ex

SP US

Entered	PLS	Engineer	JEC	Sales	MF	Approved	NF	Spec Number:	
Date	11/10/08	Date	11/10/08	Date	11/10/08	Date	11/7/08		7981

IMI SENSORS
A PCB PIEZOTRONICS DIV.
3425 Walden Avenue, Depew, NY 14043

Phone: 800-959-4464
Fax: 716-684-3823
E-Mail: imi@pcb.com

All specifications are at room temperature unless otherwise specified.
In the interest of constant product improvement, we reserve the right to change specifications without notice.
ICP® is a registered trademark of PCB Group, Inc.

APPLICATION

NEXT ASS'Y	USED ON	VAR

REVISIONS

REV	DESCRIPTION	ECN	DATE	APP'D
B	REVISED PER ECN	9995	1/27/99	DM 1/99
C	UPDATE FOR UNIFORMITY	13113	2/21/01	DM 3/01

7777

TOP VIEW OF CONNECTOR

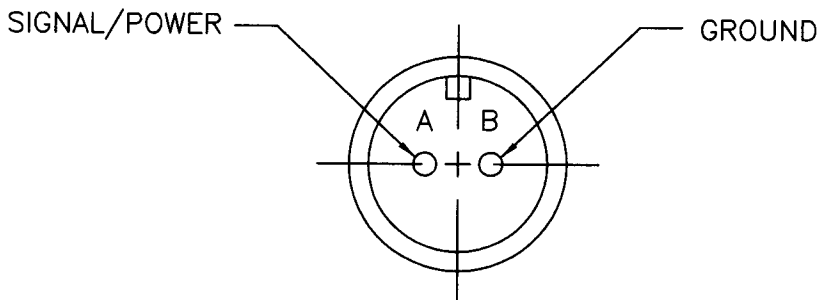

ELECTRICAL CONNECTOR
5/8-24 UNEF-2A
2-PIN (MIL-C-5015)

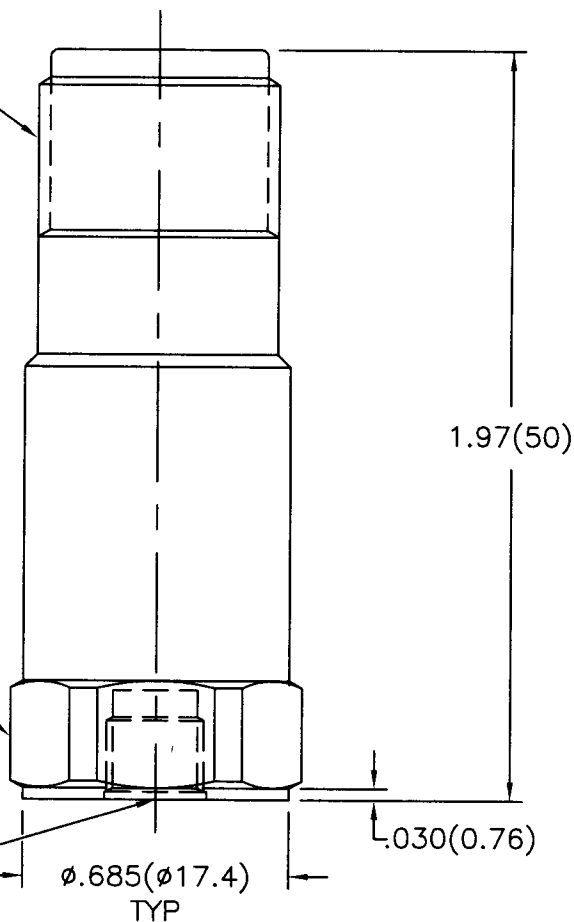

PCB Piezotronics Inc. claims proprietary rights in the information disclosed herein. Neither it nor any reproduction thereof will be disclosed to others without written consent of PCB Piezotronics Inc.

UNLESS SPECIFIED TOLERANCES

DIMENSIONS IN INCHES	DIMENSIONS IN MILLIMETERS (IN PARENTHESIS)
DECIMALS XX ±.01	DECIMALS XX ±0.3
XXX ±.005	XXX ±0.13
ANGLES ±2 DEGREES	ANGLES ±2 DEGREES
FILLETS AND RADII .003 - .005	FILLETS AND RADII (0.07 - 0.13)

DRAWN	MWS	3.12.01	MFG	S.P.	3/21/01
CHK'D	DM	3/16/01	ENGR	N.F.	3/14/01
APP'D	DM	3/22/01	SALES	EGY	3/23/01
TITLE OUTLINE DRAWING MODELS 623C00, M, & 623C01, M ACCELEROMETER					

PCB PIEZOTRONICS
3425 WALDEN AVE. DEPEW, NY 14043
(716) 684-0001 EMAIL: SALES@PCB.COM

CODE IDENT. NO. 52681
DWG. NO. 7777

SCALE: 2X SHEET 1 OF 1

INSTRUCTIONS FOR USE - EX(XX)622yzzz/aaa, EX(XX)623yzzz/aaa, EX(XX)625yzzz/aaa, and EX(XX)628yzzz/aaa Series

Model(s)	<p>EX(XX)622yzzz/aaa, EX(XX)623yzzz/aaa, EX(XX)625yzzz/aaa, and EX(XX)628yzzz/aaa Series where: (XX) - Represents one or more optional designations including: M – Metric mounting hardware and cable TO – Temperature Output Sensor HT – High Temperature Accelerometer (325°F, 163°C) VO – Velocity Output Sensor y – One Letter A to Z zzz – Two or Three Numbers 00 to 999 which depicts sensitivity, filtering, or bias etc. aaa – Designates cable length and/or connector type</p>
Markings	<p>PCB Depew, NY LCIE 03 ATEX 6114 X / 03 LCIE 15 ATEX 1007 X / 02 IECE_x LCIE 15.0016X/02 Ex ia IIC T4 Ga Ex nA IIC T4 Gc -54°C ≤ Ta ≤ +121°C (-54°C ≤ Ta ≤ +163°C “T3” for HT option)</p>
Putting Into Service	<p>Powering: All ICP[®] sensors require constant current excitation for proper operation. For this reason, use only PCB constant-current signal conditioners or other approved constant-current sources. The power supply consists of a current-regulated, 18 to 30 VDC source. This power is regulated by a current-limiting circuit, which provides the constant-current excitation required for proper operation of ICP[®] sensors. In general, battery-powered devices offer versatility for portable, low-noise measurements, whereas line-powered units provide the capability for continuous monitoring. Consult the Vibration Division’s product catalog for more information about signal conditioners. NOTE: <i>Under no circumstances should a voltage be supplied to an ICP[®] accelerometer without a current-regulating diode or equivalent electrical circuit. This may include ohmmeters, multi-meters and continuity testers.</i></p>
Safe Use	<p>After completing the system setup, switch on the signal conditioner and allow 1 to 2 minutes for the system to stabilize. The meter (or LED) on the signal conditioner should be reading “green.” This indicates proper operation and you may begin taking measurements. If a faulty condition is indicated (red or yellow reading), first check all system connections, then check the functionality of the cable and signal conditioner. If the system still does not operate properly, consult a PCB factory representative. NOTE: <i>Always operate the accelerometer within the limitations listed on the enclosed Specification Sheet. Operating the device outside these parameters can cause temporary or permanent damage to the sensor.</i></p>
Assembling	<p>The EX(XX)622yzzz/aaa, EX(XX)623yzzz/aaa, EX(XX)625yzzz/aaa, and EX(XX)628yzzz/aaa series have a hermetically sealed stainless steel, with a sealed integral cable, and do not require any assembly. Only mounting to the machine being monitored using standard mounting accessories.</p>
Dismantling	<p>Other than removal from the mounting, there is no disassembly of the sensor required to take it out of service.</p>
Maintenance	<p>Routine maintenance, such as the cleaning of electrical connectors, housings, and mounting surfaces with solutions and techniques that will not harm the physical material of construction, is acceptable.</p>

Serviceing	Due to the sophisticated nature of the sensors and associated instrumentation provided by PCB Piezotronics, user servicing or repair is not recommended and, if attempted, may void the factory warranty. However, routine calibration of sensors and associated instrumentation is recommended as this helps build confidence in measurement accuracy and acquired data.
Repair	In the event that equipment becomes damaged or ceases to operate, arrangements should be made to return the equipment to PCB Piezotronics for repair. User servicing or repair is not recommended and, if attempted, may void the factory warranty.
Installation	<p>Overview: Sensor must be mounted in order to be put into service. When choosing a mounting method, consider closely both the advantages and disadvantages of each technique. Characteristics like location, ruggedness, amplitude range, accessibility, temperature, and portability are extremely critical. However, the most important and often overlooked consideration is the effect the mounting technique has on the high-frequency performance of the accelerometer. Mounting methods include: Stud mount, adhesive mount, magnetic mount, handheld, or probe tip mount.</p> <p>Cabling: Care and attention to cable installation and cable condition is essential as the reliability and accuracy of any measurement system is no better than that of its weakest link. Due to the nature of vibration measurements, all sensor cables will ultimately fatigue and fail. Good installation practice will extend the life of a cable, however, it is highly recommended to keep spare cables on hand to enable continuation of the test in the event of a cable failure.</p>
Adjustment	The sensor is a sealed device and no user adjustments are possible. However, routine calibration of sensors by the manufacturer is recommended as this helps build confidence in measurement accuracy and acquired data.
Danger Areas (for pressure-relief devices)	N/A – not a pressure relief device.
Training Instructions	Industrial sensors must be installed in Hazardous Locations by trained professionals according to EN/IEC 60079-14 requirements.
Details on Safety of Protection Category	<p>Ex ia is “intrinsic safety”, which limits the energy of sparks and surface temperatures to safe levels.</p> <p>Ex nA is “Non-Sparking”, which ensures that there is no risk of arcing and sparking or hot surfaces during normal operation</p>
Entity Parameters and Limits (Values)	<p>Temperature Range: -54°C to +121°C (-54°C to +163°C for the HT option)</p> <p>For Connector Series: $U_i = 28V$, $I_i = 93\text{ mA}$, $P_i = 1W$, $C_i = 6.5nF$, $L_i = 0\mu H$</p> <p>For Connector Series with “VO” option: $U_i = 28V$, $I_i = 93\text{ mA}$, $P_i = 1W$, $C_i = 69.2nF$, $L_i = 0\mu H$</p> <p>For Cable Series with a max cable length of 305 m (1000 ft): $U_i = 28V$, $I_i = 93\text{ mA}$, $P_i = 1W$, $C_i = 67.5nF$, $L_i = 305\mu H$</p> <p>For Cable Series with a max cable length of 61 m (200 ft) with “VO” option: $U_i = 28V$, $I_i = 93\text{ mA}$, $P_i = 1W$, $C_i = 81.4nF$, $L_i = 61\mu H$</p>
Special Conditions of Use	<p>Version Ex ia :</p> <p>The apparatus must only be connected to a certified associated intrinsically safe equipment. This combination must be compatible regarding intrinsic safety rules (see electrical parameters). The apparatus shall be connected according to drawing 65040 (page 1/2)</p> <p>The equipment must be earthed in accordance with EN/IEC 60079-0.</p>

	<p>Version Ex nA:</p> <p>All connections must maintain a minimum of IP54. The apparatus must be only connect to an equipment whose electrical parameters are compatible with the electrical parameters. The apparatus shall be connected according to drawing 65040 (page 2/2).</p> <p>The Equipment shall be earthed according with EN/IEC 60079-0. Provision shall be made, external to the equipment, to provide the transient protection device to be set at a level not exceeding 119V.</p> <p>Do not Separate when energized.</p>
Essential Characteristics of tools fitted to the system (if any).	N/A – No tools are fitted to the system.
Drawings and Diagrams	65009, 65010, 65038, 65040
Other	<p>For ATEX protection “ia” – EN 60079-0 + A11:2013 and EN 60079-11:2012</p> <p>For ATEX protection “nA” – EN 60079-0 + A11:2013 and EN 60079-15:2010</p> <p>For IECEx protection “ia” – IEC 60079-0 Ed. 6 and IEC 60079-11 Ed. 6</p> <p>For IECEx protection “nA” – IEC 60079-0 Ed. 6 and IEC 60079-15 Ed. 4</p>

Note: Literature (such as the manual or marketing materials) describing the equipment or protective system must not contradict the instructions with regard to safety aspects.

Note: IMI Sensors is a Division of PCB Piezotronics. This Division is wholly contained in the PCB Piezotronics manufacturing facility at 3425 Walden Avenue, Depew, New York. Same address, same manufacturing facility. Some of the documentation contained in the Technical File associated with this application is labeled IMI Sensors, A PCB Piezotronics Div. and some is labeled simply PCB Piezotronics. PCB Piezotronics labeled drawing are higher level drawings which are used across multiple divisions, while IMI labeled drawing are specific to IMI models. There will be a mixture of IMI and PCB drawing to support this application, and in reality they are the same entity however with an associated trade name (IMI) that is recognized by our customer base.



LCIE

ATTESTATION D'EXAMEN DE TYPE TYPE EXAMINATION CERTIFICATE



1 Version : 02

LCIE 15 ATEX 1007 X

Issue : 02

Directive 2014/34/UE

Directive 2014/34/EU

2 Appareil ou Système de Protection destiné à être utilisé en Atmosphères Explosibles

Equipment or Protective System Intended for use in Potentially Explosive Atmospheres

3 Produit :
Capteurs de vibration

Product :
Vibration sensors

Type: EX(XX)622yzzz/aaa, EX(XX)623yzzz/aaa, EX(XX)625yzzz/aaa, EX(XX)628yzzz/aaa

4 Fabricant :

Manufacturer :

PCB Piezotronics

5 Adresse :

Address :

3425 Walden Avenue
Depew, New York 14043
USA

6 Ce produit et ses variantes éventuelles acceptées sont décrits dans l'annexe de la présente attestation et dans les documents descriptifs cités en référence.

This product and any acceptable variation thereto are specified in the schedule to this certificate and the documents therein referred to.

7 Le LCIE certifie que ce produit est conforme aux Exigences Essentielles de Sécurité et de Santé pour la conception et la construction de produits destinés à être utilisés en atmosphères explosibles, données dans l'annexe II de la Directive.

LCIE certifies that product has been found to comply with the Essential Health and Safety Requirements relating to the design and construction of products intended for use in potentially explosive atmospheres, given in Annex II to the Directive.

Les résultats des vérifications et essais figurent dans le(s) rapport(s) confidentiel(s) N° :

The examination and test results are recorded in confidential report(s) N°:

127598-655825; 143168-689175; 156608-724494

8 Le respect des Exigences Essentielles de Sécurité et de Santé est assuré par la conformité à :

Compliance with the Essential Health and Safety Requirements has been assured by compliance with :

EN 60079-0:2012 + A11:2013
EN 60079-15:2010

9 Le signe « X » lorsqu'il est placé à la suite du numéro de l'attestation, indique que cet appareil est soumis aux conditions particulières d'utilisation, mentionnées dans l'annexe de cette attestation.

If the sign "X" is placed after the certificate number, it indicates that the product is subject to the Specific Conditions of Use specified in the schedule to this certificate.

10 Cette Attestation d'Examen de Type concerne uniquement la conception et la construction du produit spécifié. Des exigences supplémentaires de la directive sont applicables pour la fabrication et la fourniture du produit. Ces dernières ne sont pas couvertes par la présente attestation.

This Type Examination Certificate relates only to the design and construction of the specified product. Further requirements of the Directive apply to the manufacturing process and supply of this product. These are not covered by this certificate.

11 Le marquage du produit est mentionné dans l'annexe de cette attestation.

The marking of the product is specified in the schedule to this certificate.

Fontenay-aux-Roses, le 1er août 2019

Responsable de Certification

Certification Officer

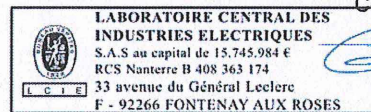

Julien Gauthier
(Signature)

Seul le texte en français peut engager la responsabilité du LCIE. Ce document ne peut être reproduit que dans son intégralité, sans aucune modification. Il est établi en accord avec le référentiel de certification ATEX du LCIE. The LCIE's liability applies only on the French text. This document may only be reproduced in its entirety and without any change. It is issued in accordance with LCIE's ATEX Certification Rules.
CERT-ATEX-FORM 05 Rev. 04

Page 1 of 4

LCIE

Laboratoire Central des Industries Electriques
Une société de Bureau Veritas

33 Avenue du Général Leclerc
92260 Fontenay-aux-Roses
FRANCE

WWW.LCIE.FR

12 DESCRIPTION DU PRODUIT

Les appareils sont des capteurs de vibration utilisant un cristal de quartz pour convertir une mesure de vibration mécanique en un signal électrique.

L'appareil se compose d'une enveloppe métallique cylindrique scellée contenant un circuit imprimé et un élément cristal de quartz, d'un connecteur ou d'un câble intégral pour connexion externe.

DETAIL DE LA GAMME

Les modèles sont électriquement identiques mais mécaniquement différents :

- EX(XX)622yzzz/aaa : Capteur avec connecteur ou câble intégré de sortie dirigée vers le haut
- EX(XX)623yzzz/aaa : Capteur avec connecteur ou câble intégré de sortie dirigée vers le haut
- EX(XX)625yzzz/aaa : Capteur avec connecteur ou câble intégré de sortie latérale
- EX(XX)628yzzz/aaa : Capteur avec connecteur ou câble intégré de sortie dirigée vers le haut

DESCRIPTION OF PRODUCT

The equipment are vibration sensors using a quartz crystal to convert a mechanical vibration measurement into an electric signal.

The equipment consists of a sealed cylindrical metal body which houses a PCB board and a piezo crystal element, and a connector or an integral cable for external connection.

RANGE DETAILS

Models are electrical identical, but mechanical different:

- EX(XX)622yzzz/aaa: Sensor with top exit connector or integral cable
- EX(XX)623yzzz/aaa: Sensor with top exit connector or integral cable
- EX(XX)625yzzz/aaa: Sensor with side exit connector or integral cable
- EX(XX)628yzzz/aaa: Sensor with top exit connector or integral cable

Symbole <i>Symbol</i>	Description <i>Description</i>	
XX	HT	Accéléromètre à haute température <i>High temperature accelerometer</i>
	M	Câble et matériel de montage métrique <i>Metric mounting hardware and cable</i>
	TO	Capteur de température de sortie <i>Temperature output sensor</i>
	VO	Capteur de vitesse de sortie <i>Velocity output sensor</i>
y	Une lettre A à Z décrivant le niveau de révision <i>One letter A to Z depicts revision level</i>	
zzz	Deux ou trois chiffres 00 à 999 décrivant la sensibilité, le filtrage ou le biais etc. <i>Two or three numbers 00 to 999 depicts sensitivity, filtering or bias etc.</i>	
aaa	Longueur de câble et/ou type de connecteur <i>Cable length and/or connector type</i>	

CARACTERISTIQUES

Paramètres électriques : U ≤ 28V, I ≤ 93mA, P ≤ 1W

RATINGS

Electrical parameters : U ≤ 28V, I ≤ 93mA, P ≤ 1W

MARQUAGE

Le marquage du produit doit comprendre :

Marquage complet:

PCB Piezotronics ou IMI Sensors ou IMI

Adresse : ...

Type : ... (1)

N° de fabrication : ...

Année de fabrication : ...

⊕ II 3 G

Ex nA IIC T3 Gc (-54°C ≤ T_{amb} ≤ +163°C) pour modèles avec option HT

Ex nA IIC T4 Gc (-54°C ≤ T_{amb} ≤ +121°C) pour modèles sans option HT

LCIE 15 ATEX 1007 X

U ≤ 28V, I ≤ 93mA, P ≤ 1W

AVERTISSEMENT - NE PAS SEPARER SOUS TENSION

Marquage réduit :

PCB Piezotronics ou IMI Sensors ou IMI

Type : ... (1)

N° de fabrication : ...

Année de fabrication : ...

⊕ II 3 G

Ex nA IIC T3 Gc (-54°C ≤ T_{amb} ≤ +163°C) pour modèles avec option HT

Ex nA IIC T4 Gc (-54°C ≤ T_{amb} ≤ +121°C) pour modèles sans option HT

LCIE 15 ATEX 1007 X

U ≤ 28V, I ≤ 93mA, P ≤ 1W

(1) : à compléter selon modèles

L'appareil doit également comporter le marquage normalement prévu par les normes de construction qui le concernent sous la responsabilité du fabricant.

13 CONDITIONS PARTICULIERES D'UTILISATION

- a. L'appareil ne doit être raccordé qu'à un équipement dont les paramètres électriques sont compatibles avec les paramètres électriques définis au paragraphe 12.
- c. L'appareil doit être raccordé conformément aux instructions du constructeur (voir plan 65040).
- d. Pour l'installation finale, l'appareil doit être raccordé conformément aux exigences de la norme EN 60079-14, en fournissant et en maintenant un degré de protection d'au moins IP54 selon les exigences de la norme EN 60079-0.
- e. Des mesures doivent être prises, à l'extérieur de l'appareil, afin que le dispositif de protection contre les transitoires soit réglé à un niveau n'excédant pas 119 V.
- f. L'appareil doit être mis à la terre conformément à la norme EN 60079-0.
- g. AVERTISSEMENT – NE PAS SEPARER SOUS TENSION

MARKING

The marking of the product shall include the following :

Complete marking:

PCB Piezotronics or IMI sensors or IMI

Address: ...

Type: ... (1)

Serial number: ...

Year of construction: ...

⊕ II 3 G

Ex nA IIC T3 Gc (-54°C ≤ T_{amb} ≤ +163°C) for models with HT option

Ex nA IIC T4 Gc (-54°C ≤ T_{amb} ≤ +121°C) for models without HT option

LCIE 15 ATEX 1007 X

U ≤ 28V, I ≤ 93mA, P ≤ 1W

WARNING - DO NOT SEPARATE WHEN ENERGIZED

Reduced marking :

PCB Piezotronics or IMI sensors or IMI

Type: ... (1)

Serial number: ...

Year of construction: ...

⊕ II 3 G

Ex nA IIC T3 Gc (-54°C ≤ T_{amb} ≤ +163°C) for models with HT option

Ex nA IIC T4 Gc (-54°C ≤ T_{amb} ≤ +121°C) for models without HT option

LCIE 15 ATEX 1007 X

U ≤ 28V, I ≤ 93mA, P ≤ 1W

(1) : completed following models

The equipment shall also bear the usual marking required by the product standards applying to such equipment under the manufacturer responsibility.

SPECIFIC CONDITIONS OF USE

The apparatus must be only connected to an equipment whose electrical parameters are compatible with the electrical parameters indicated in clause 12.

The equipment shall be connected in accordance with the manufacturer's installation instructions (see drawing 65040).

For final installation, the device shall be connected in compliance with EN 60079-14 requirements, providing and maintaining degree of protection at least IP54 according to EN 60079-0 requirements.

Provision shall be made, external to the equipment, to provide the transient protection device to be set at a level not exceeding 119 V.

The equipment shall be earthed in accordance with EN 60079-0.

WARNING – DO NOT SEPARATE WHEN ENERGIZED.

Seul le texte en français peut engager la responsabilité de LCIE. Ce document ne peut être reproduit que dans son intégralité, sans aucune modification. Il est établi en accord avec le référentiel de certification ATEX du LCIE. The LCIE's liability applies only on the French text. This document may only be reproduced in its entirety and without any change. It is issued in accordance with LCIE's [ATEX Certification Rules](#).
CERT-ATEX-FORM 05 Rev. 04

Page 3 of 4



ATTESTATION D'EXAMEN DE TYPE - ANNEXE

TYPE EXAMINATION CERTIFICATE - SCHEDULE

1 Version : 02

LCIE 15 ATEX 1007 X

Issue : 02

14 EXIGENCES ESSENTIELLES DE SANTE ET DE SECURITE

Couvertes par les normes listées au point 8.

ESSENTIAL HEALTH AND SAFETY REQUIREMENTS

Covered by standards listed at 8.

15 DOCUMENTS DESCRIPTIFS

DESCRIPTIVE DOCUMENTS

N°	Description	Reference	Rev.	Date	Page(s)
1.	Technical file (ATEX nA)	65043	A	2018/12/14	43
2.	Instruction	32241	-	-	3

16 INFORMATIONS COMPLEMENTAIRES

Essais individuels

Chaque appareil doit être soumis à un essai de rigidité diélectrique de 600 V 50 Hz appliqué pendant 100 ms entre les bornes et le boîtier.

ADDITIONAL INFORMATION

Routine tests

Each equipment must be submitted to a dielectric strength 600 V 50 Hz applied during 100 ms between the terminals and the housing.

17 DETAILS DES MODIFICATIONS DE L'ATTESTATION

Version 00 : Evaluation de la conformité selon les normes EN 2015/05/05 60079-0:2012 + A11:2013 et EN 60079-15:2010

Version 01 : - Ajout d'un nouveau modèle EX(XX)625xyyy/aaa
 2017/02/22 - Mise à jour de la nomenclature des modèles.
 - Distinction entre le nom du constructeur (PCB Piezotronics) et le nom de la marque commerciale (IMI Sensors ou IMI)
 - Ajout d'une nouvelle option de sortie de température.

Version 02 : Pour modèle haute température (HT) : correction
 Actuelle de la plage de température ambiante et la classe de température.

DETAILS OF CERTIFICATE CHANGES

Issue 00: Conformity assessment according to EN 60079-0:2012 + A11:2013 and EN 60079-15:2010 standards.

Issue 01: - Addition of a new model (EX(XX)625xyyy/aaa).
 2017/02/22 - Update of the nomenclature of the models.
 - Distinction between the name of the manufacturer (PCB Piezotronics) and the name of the trademark (IMI sensors or IMI)
 - Addition of a new option of temperature output.

Issue 02: For High Temperature (HT) model: correction of
 Current temperature range and temperature class.

Seul le texte en français peut engager la responsabilité du LCIE. Ce document ne peut être reproduit que dans son intégralité, sans aucune modification. Il est établi en accord avec le [référentiel de certification ATEX](#) du LCIE. *The LCIE's liability applies only on the French text. This document may only be reproduced in its entirety and without any change. It is issued in accordance with LCIE's [ATEX Certification Rules](#).*
 CERT-ATEX-FORM 05 Rev. 04

Page 4 of 4

LCIE

Laboratoire Central des Industries Electriques
 Une société de Bureau Veritas

33 Avenue du Général Leclerc
 92260 Fontenay-aux-Roses
 FRANCE

WWW.LCIE.FR

1 Version : 01

LCIE 15 ATEX 1007 X

Issue : 01

Directive 2014/34/UE

Directive 2014/34/EU

2 Appareil ou Système de Protection destiné à être utilisé en Atmosphères Explosibles

Equipment or Protective System Intended for use in Potentially Explosive Atmospheres

3 Produit :
Capteurs de vibration

Product :
Vibration sensors

Type: EX(XX)622yzzz/aaa, EX(XX)623yzzz/aaa, EX(XX)625yzzz/aaa, EX(XX)628yzzz/aaa

4 Fabricant :

Manufacturer :

PCB Piezotronics

5 Adresse :

Address :

3425 Walden Avenue
Depew, New York 14043
USA

6 Ce produit et ses variantes éventuelles acceptées sont décrits dans l'annexe de la présente attestation et dans les documents descriptifs cités en référence.

This product any acceptable variation thereto is specified in the schedule to this certificate and the documents therein referred to.

7 Le LCIE certifie que ce produit est conforme aux Exigences Essentielles de Sécurité et de Santé pour la conception et la construction de produits destinés à être utilisés en atmosphères explosibles, données dans l'annexe II de la Directive.

LCIE certifies that product has been found to comply with the Essential Health and Safety Requirements relating to the design and construction of products intended for use in potentially explosive atmospheres, given in Annex II to the Directive.

Les résultats des vérifications et essais figurent dans le(s) rapport(s) confidentiel(s) N° :

The examination and test results are recorded in confidential report(s) N°:

127598-655825, 143168-689175.

8 Le respect des Exigences Essentielles de Sécurité et de Santé est assuré par la conformité à :

Compliance with the Essential Health and Safety Requirements has been assured by compliance with :

EN 60079-0:2012 + A11:2013, EN 60079-15:2010

9 Le signe « X » lorsqu'il est placé à la suite du numéro de l'attestation, indique que cet appareil est soumis aux conditions particulières d'utilisation, mentionnées dans l'annexe de cette attestation.

If the sign "X" is placed after the certificate number, it indicates that the product is subject to the Specific Conditions of Use specified in the schedule to this certificate.

10 Cette Attestation d'Examen de Type concerne uniquement la conception et la construction du produit spécifié. Des exigences supplémentaires de la directive sont applicables pour la fabrication et la fourniture du produit. Ces dernières ne sont pas couvertes par la présente attestation.

This Type Examination Certificate relates only to the design and construction of the specified product. Further requirements of the Directive apply to the manufacturing process and supply of this product. These are not covered by this certificate.

11 Le marquage du produit est mentionné dans l'annexe de cette attestation.

The marking of the product is specified in the schedule to this certificate.

Fontenay-aux-Roses, le 20 février 2017

Responsable des Opérations de Certification
Manager of Certification Operations
Didier Bourgès



ATTESTATION D'EXAMEN DE TYPE - ANNEXE

TYPE EXAMINATION CERTIFICATE - SCHEDULE

1 Version : 01

LCIE 15 ATEX 1007 X

Issue : 01

12 DESCRIPTION DU PRODUIT

Les capteurs de vibration type EX(XX)622yzzz/aaa, EX(XX)623yzzz/aaa, EX(XX)625yzzz/aaa ou EX(XX)628yzzz/aaa utilisent un cristal de quartz pour convertir une mesure de vibration mécanique en un signal électrique.
Le capteur se compose d'un boîtier métallique cylindrique scellé, qui abrite une carte de substrat PCB et un élément piézo-cristal, et un connecteur ou un câble intégré pour raccordement externe.

Paramètres électriques :

$U \leq 28V, I \leq 93mA, P \leq 1W$

DETAIL DE LA GAMME

Les modèles sont électriquement identiques, mais mécaniquement différents:
EX(XX)622yzzz/aaa: Capteur avec connecteur ou câble intégré de sortie dirigée vers le haut.
EX(XX)623yzzz/aaa: Capteur avec connecteur ou câble intégré de sortie dirigée vers le haut.
EX(XX)625yzzz/aaa: Capteur avec connecteur ou câble intégré de sortie latérale.
EX(XX)628yzzz/aaa: Capteur avec connecteur ou câble intégré de sortie dirigée vers le haut.

DESCRIPTION OF PRODUCT

The vibration sensors type EX(XX)622yzzz/aaa, EX(XX)623yzzz/aaa, EX(XX)625yzzz/aaa or EX(XX)628yzzz/aaa utilise a quartz crystal to convert a mechanical vibration measurement into an electric signal.
The sensor consists of a sealed cylindrical metal case, which houses a PCB substrate board and a piezo-crystal element, and a connector or an integral cable for external connection.

Electrical parameters:

RANGE DETAILS

Models are electrically identical, but mechanically different:
EX(XX)622yzzz/aaa: Sensor with top exit connector or integral cable
EX(XX)623yzzz/aaa: Sensor with top exit connector or integral cable
EX(XX)625yzzz/aaa: Sensor with side exit connector or integral cable
EX(XX)628yzzz/aaa: Sensor with top exit connector or integral cable.

Symbole <i>Symbol</i>	Détail <i>Detail</i>	
XX	HT	Accéléromètre à haute température <i>High temperature accelerometer</i>
	M	Câble et matériel de montage métrique <i>Metric mounting hardware and cable</i>
	TO	Capteur de température de sortie <i>Temperature output sensor</i>
	VO	Capteur de vitesse de sortie <i>Velocity output sensor</i>
y	Une lettre de A à Z <i>One letter A to Z</i>	
zzz	Deux ou trois chiffres de 00 à 999 <i>Two or three numbers 00 to 999</i>	
aaa	Longueur de câble et/ou type de connecteur <i>Cable length and/or connector type</i>	

MARQUAGE

Le marquage du produit doit comprendre :

Marquage complet :

PCB Piezotronics ou IMI sensors ou IMI

Adresse : ...

Type : ...

Numéro de fabrication : ... Année de construction : ...

II 3 G

Ex nA IIC T4 Gc

LCIE 15 ATEX 1007 X

-54°C ≤ T_{amb} ≤ +121°C

AVERTISSEMENT - NE PAS SEPARER SOUS TENSION

MARKING

The marking of the product shall include the following :

Full marking:

PCB Piezotronics or IMI sensors or IMI

Address: ...

Type: ...

Serial number: ... Year of construction: ...

II 3 G

Ex nA IIC T4 Gc

LCIE 15 ATEX 1007 X

-54°C ≤ T_{amb} ≤ +121°C

WARNING - DO NOT SEPARATE WHEN ENERGIZED

Seul le texte en français peut engager la responsabilité du LCIE. Ce document ne peut être reproduit que dans son intégralité, sans aucune modification. Il est établi en accord avec le [référentiel de certification ATEX](#) du LCIE. The LCIE's liability applies only on the French text. This document may only be reproduced in its entirety and without any change. It is issued in accordance with LCIE's [ATEX Certification Rules](#).
CERT-ATEX-FORM 05 Rev. 02

Page 2 of 4

LCIE

Laboratoire Central des Industries Electriques

Une société de Bureau Veritas

33 Avenue du Général Leclerc

92260 Fontenay-aux-Roses

FRANCE

WWW.LCIE.FR



L C I E

ATTESTATION D'EXAMEN DE TYPE - ANNEXE

TYPE EXAMINATION CERTIFICATE - SCHEDULE

1 Version : 01

LCIE 15 ATEX 1007 X

Issue : 01

Marquage réduit :

PCB Piezotronics ou IMI sensors ou IMI

Type : ...

Numéro de fabrication : ...

Année de construction : ...

II 3 G

Ex nA IIC T4 Gc

LCIE 15 ATEX 1007 X

Ui : ... V, li : ... mA, Pi : ...W

-54°C ≤ T_{amb} ≤ +121°C

L'appareil doit également comporter le marquage normalement prévu par les normes de construction qui le concernent sous la responsabilité du fabricant.

Reduced marking:

PCB Piezotronics or IMI sensors or IMI

Type: ...

Serial number: ...

Year of construction: ...

II 3 G

Ex nA IIC T4 Gc

LCIE 15 ATEX 1007 X

Ui : ... V, li : ... mA, Pi : ...W

-54°C ≤ T_{amb} ≤ +121°C

The equipment shall also bear the usual marking required by the product standards applying to such equipment under the manufacturer responsibility.

13 CONDITIONS PARTICULIERES D'UTILISATION

- L'appareil ne doit être raccordé qu'à un équipement dont les paramètres électriques sont compatibles avec les paramètres électriques.
- Température ambiante de fonctionnement : -54°C à +121°C.
- L'appareil doit être raccordé conformément au manuel d'instruction.
- L'utilisateur final devra prendre toutes les précautions nécessaires pour maintenir le degré de protection minimum IP54 de la connexion du capteur lors de son raccordement selon les préconisations de la norme EN 60079-14.
- AVERTISSEMENT - NE PAS SEPARER SOUS TENSION

SPECIFIC CONDITIONS OF USE

The apparatus must be only connected to an equipment whose electrical parameters are compatible with the electrical parameters.

Operating ambient temperature: -54°C to +121°C

The apparatus must be connected according to instruction manual.

For final installation, the device shall be connected in compliance with EN 60079-14 requirements, providing and maintaining degree of protection at last IP54.

WARNING - DO NOT SEPARATE WHEN ENERGIZED

14 EXIGENCES ESSENTIELLES DE SANTE ET DE SECURITE

Couvertes par les normes listées au point 8.

ESSENTIAL HEALTH AND SAFETY REQUIREMENTS

Covered by standards listed at 8.

15 DOCUMENTS DESCRIPTIFS

N°	Description	Reference	Rev.	Date	Page(s)
1.	Instructions	32241	C	2016/09/11	3
2.	Technical file	65043	NR	2016/02/09	45

DESCRIPTIVE DOCUMENTS**16 INFORMATIONS COMPLEMENTAIRES****Essais individuels**

Chaque exemplaire du matériel devra avoir subi un essai de rigidité diélectrique à 600V 50Hz pendant 100ms entre les bornes et l'enveloppe.

En accord avec l'Article 41 de la Directive 2014/34/UE, les attestations d'examen de type mentionnant la Directive 94/9/CE émises avant la date d'application de la Directive 2014/34/UE (20 avril 2016) peuvent être considérées comme émises en accord avec la Directive 2014/34/UE. Les nouvelles versions de ces attestations peuvent conserver le numéro de l'attestation d'origine émise avant le 20 avril 2016.

ADDITIONAL INFORMATION**Routine tests**

Each apparatus must be submitted to a dielectric strength 600V 50Hz during 100ms between the terminals and the housing.

In accordance with Article 41 of Directive 2014/34/EU, Type Examination Certificates referring to Directive 94/9/EC that were in existence prior to the date of application of Directive 2014/34/EU (20 April 2016) may be referenced as if they were issued in accordance with Directive 2014/34/EU. New issues of such certificates may continue to bear the original certificate number issued prior to 20 April 2016.

Seul le texte en français peut engager la responsabilité du LCIE. Ce document ne peut être reproduit que dans son intégralité, sans aucune modification. Il est établi en accord avec le [référentiel de certification ATEX](#) du LCIE. *The LCIE's liability applies only on the French text. This document may only be reproduced in its entirety and without any change. It is issued in accordance with LCIE's [ATEX Certification Rules](#).*
CERT-ATEX-FORM 05 Rev. 02

Page 3 of 4

LCIE

Laboratoire Central des Industries Electriques
Une société de Bureau Veritas

33 Avenue du Général Leclerc
92260 Fontenay-aux-Roses
FRANCE

WWW.LCIE.FR



ATTESTATION D'EXAMEN DE TYPE - ANNEXE

TYPE EXAMINATION CERTIFICATE - SCHEDULE

1 Version : 01

LCIE 15 ATEX 1007 X

Issue : 01

17 DETAILS DES MODIFICATIONS

Version00 : Evaluation initial selon les normes EN 60079-05/05/2015 0:2012 + A11:2013 et EN 60079-15:2010.

- Version 01 :
- Ajout d'un nouveau modèle EX(XX)625yzzz/aaa.
 - Ajout d'une nouvelle option de sortie de température.
 - Mise à jour de la nomenclature des modèles.
 - Distinction entre le nom du fabricant (PCB Pizotronic) et le nom de la marque commerciale (IMI sensors ou IMI).

DETAILS OF CHANGES

Issue 00: Initial assessment according to EN 60079-2015/05/05 0:2012 + A11:2013 and EN 60079-15:2010.

- Issue 01:
- Addition of a new model EX(XX)625yzzz/aaa.
 - Addition of a new option of temperature output.
 - Update of the nomenclature of the models.
 - Distinction between the name of the manufacturer (PCB Piezotronics) and the name of the trademark (IMI sensors or IMI).

Seul le texte en français peut engager la responsabilité du LCIE. Ce document ne peut être reproduit que dans son intégralité, sans aucune modification. Il est établi en accord avec le [référentiel de certification ATEX](#) du LCIE. *The LCIE's liability applies only on the French text. This document may only be reproduced in its entirety and without any change. It is issued in accordance with LCIE's [ATEX Certification Rules](#).*
CERT-ATEX-FORM 05 Rev. 02

Page 4 of 4

LCIE

Laboratoire Central des Industries Electriques
Une société de Bureau Veritas

33 Avenue du Général Leclerc
92260 Fontenay-aux-Roses
FRANCE

WWW.LCIE.FR



LCIE

1 **ATTESTATION D'EXAMEN DE TYPE VOLONTAIRE**

2 **Appareil ou composant** destiné à être utilisé en atmosphères explosibles
(Directive 94/9/CE)



VOLUNTARY TYPE EXAMINATION CERTIFICATE

Equipment or component intended for use in potentially explosive atmospheres
(Directive 94/9/EC)

3 **Version : 00**

LCIE 15 ATEX 1007 X

Issue : 00

4 **Appareil :**
Capteurs de vibration

Equipment:
Vibration sensors

Type: EX622 series, EX623 series, EX628 series, EXVO622 series

5 **Demandeur - Fabricant**

Applicant - Manufacturer

I.M.I Sensors A PCB Piezotronics Div.

6 **Adresse :** 3425 Walden Avenue
Depew, New York 14043
USA

Address : 3425 Walden Avenue
Depew, New York 14043
USA

7 Cet appareil ou composant et ses variantes éventuelles acceptées sont décrits dans l'annexe de la présente attestation et dans les documents descriptifs cités en référence.

This equipment or component and any acceptable variation thereto are specified in the schedule to this certificate and the documents therein referred to.

8 Le LCIE certifie que cet appareil ou composant est conforme aux Exigences Essentielles de Sécurité et de Santé pour la conception d'appareils ou composants électriques de catégorie 3 ou non électriques de catégorie 2 et 3, destinés à être utilisés en atmosphères explosibles. Ces Exigences Essentielles de Sécurité et de Santé sont données dans l'annexe II de la directive 94/9/CE du Parlement européen et du Conseil du 23 mars 1994.

LCIE certifies that this equipment or component has been found to comply with the Essential Health and Safety Requirements that relates to the design, of category 3 electrical or categories 2 and 3 non electrical equipment or component, which is intended for use in potentially explosive atmospheres. These Essential Health and Safety Requirements are given in Annex II of the Directive 94/9/EC of the European Parliament and the Council of 23 March 1994.

Les résultats des vérifications et essais figurent dans le rapport confidentiel :

The examination and test results are recorded in confidential report:

N° 127598-655825

9 Le respect des Exigences Essentielles de Sécurité et de Santé est assuré par la conformité à :

Compliance with the Essential Health and Safety Requirements has been assured by compliance with :

EN 60079-0:2012 + A11 :2013
EN 60079-15:2010

10 Le signe X lorsqu'il est placé à la suite du numéro de l'attestation, indique que cet appareil est soumis aux conditions spéciales pour une utilisation sûre, mentionnées dans l'annexe de cette attestation.

If the sign X is placed after the certificate number, it indicates that the equipment is subject to special conditions for safe use specified in the schedule to this certificate.

11 Cette attestation d'examen de type volontaire concerne uniquement la conception et la construction de l'appareil ou composant spécifié conformément à la Directive 94/9/CE.

This voluntary type examination certificate relates only to the design, examination and tests of this specified equipment or component in accordance to the Directive 94/9/EC.

Des exigences supplémentaires de la directive sont applicables pour la fabrication et la fourniture de l'appareil, système de protection ou composant. Ces dernières ne sont pas couvertes par la présente attestation.

Further requirements of the directive apply to the manufacturing process and supply of this equipment or component. These are not covered by this certificate.

12 Le marquage de l'appareil ou composant est mentionné dans l'annexe de cette attestation.

The marking of the equipment or component is specified in the schedule to this certificate.

Fontenay-aux-Roses, le 5 mai 2015

Responsable de Certification
Certification Officer

Julien Gauthier

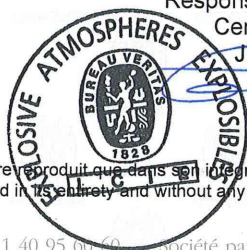

Seul le texte en français peut engager la responsabilité du LCIE. Ce document ne peut être reproduit que dans son intégralité, sans aucune modification.
The LCIE's liability applies only on the French text. This document may only be reproduced in its entirety and without any change

CERT-ATEX-FORM 05 Rev. 00
Page 1 of 3

LCIE

33, av du Général Leclerc

Tél : +33 1 40 95 00 60

société par Actions Simplifiée

Laboratoire Central

BP 8

Fax : +33 1 40 95 86 56

au capital de 15 745 984 €

des Industries Electriques

92266 Fontenay-aux-Roses cedex

contact@lcie.fr

RCS Nanterre B 408 363 174

Une société de Bureau Veritas

France

www.lcie.fr

L-01



LCIE

ATTESTATION D'EXAMEN DE TYPE VOLONTAIRE

Appareil ou composant destiné à être utilisé en atmosphères explosibles (Directive 94/9/CE)



VOLUNTARY TYPE EXAMINATION CERTIFICATE

Equipment or component intended for use in potentially explosive atmospheres (Directive 94/9/EC)

Version : 00

LCIE 15 ATEX 1007 X

Issue : 00

ANNEXE

SCHEDULE

DESCRIPTION DE L'APPAREIL OU DU COMPOSANT

Les modèles EX622,EX623,EX628 et EXVO622 sont des capteurs piezoélectriques de vibrations utilisant un cristal de quartz pour convertir une mesure de vibration mécanique en un signal électrique.

Le capteur consiste en une enveloppe métallique cylindrique scellée contenant un circuit imprimé et a élément cristal de quartz. Le circuit imprimé est raccordé à un connecteur ou a câble intégré.

Les modèles sont électriquement identiques mais mécaniquement différents :

- EX628F0X avec un connecteur 2 broches
- EX628F1X avec un câble intégré moulé
- EX622B0X avec un connecteur 2 broches
- EX622B1X avec un câble intégré moulé
- EX622A0X avec un connecteur 2 broches
- EX622A1X avec un câble intégré moulé
- EXVO622A0X avec un connecteur 2 broches
- EXVO622A1X avec un câble intégré moulé
- EXVO622B0X avec un connecteur 2 broches
- EXVO622B1X avec un câble intégré moulé
- EX623C0X avec un connecteur 2 broches
- EX623C1X avec un câble intégré moulé

X : nombre de 1 à 9 qui signifie les différents filetages, gain, réponse en fréquence, etc... Les différences proviennent des valeurs de résistances et/ou de condensateurs et sont dans les limites spécifiées dans la nomenclature.

Paramètres électriques : U ≤28V, I ≤93mA, P ≤1W

MARQUAGE

Le marquage de l'appareil ou du composant doit comprendre :

IMI Sensors Adresse : ...
 Type : EX6... ou EXVO6... (complété par le modèle)
 N° de fabrication : ...
 Année de fabrication : ...
 II 3 G
 Ex nA IIC T4 Gc
 LCIE 15 ATEX 1007 X
 -54°C ≤Ta ≤+121°C

L'appareil doit également comporter le marquage normalement prévu par les normes de construction qui le concernent sous la responsabilité du fabricant.

DOCUMENTS DESCRIPTIFS

Dossier de certification N°59350 Rév.NR du 10/04/2015. Ce dossier comprend 14 rubriques (23 pages).

DESCRIPTION OF EQUIPMENT OR COMPONENT

The model EX622,EX623,EX628 and EXVO622 series piezoelectric vibration sensors utilize a quartz crystal to convert a mechanical vibration measurement into an electric signal.

The sensor consists of a sealed cylindrical metal case, which houses a pcb substrate board and a piezo crystal element. The circuitry is connected to a connector or an integral cable.

Models are electrical identical, but mechanical different :

- EX628F0X with top 2-pin connector
- EX628F1X with integral molded cable
- EX622B0X with top 2-pin connector
- EX622B1X with integral molded cable
- EX622A0X with top 2-pin connector
- EX622A1X with integral molded cable
- EXVO622A0X with top 2-pin connector
- EXVO622A1X with integral molded cable
- EXVO622B0X with top 2-pin connector
- EXVO622B1X with integral molded cable
- EX623C0X with top 2-pin connector
- EX623C1X with integral molded cable

X is a number from 0-9 that signifies changes to filtering, gain, frequency response etc. The changes pertain to values of resistors and/or capacitors and are within the limits specified in the component listing.

Electrical parameters : U ≤28V, I ≤93mA, P ≤1W

MARKING

The marking of the equipment or component shall include the following :

IMI Sensors Address : ...
 Type : EX6... or EXVO6... (completed with the model)
 Serial number : ...
 Year of construction : ...
 II 3 G
 Ex nA IIC T4 Gc
 LCIE 15 ATEX 1007 X
 -54°C ≤Ta ≤+121°C

The equipment shall also bear the usual marking required by the product standards applying to such equipment under the manufacturer responsibility.

DESCRIPTIVE DOCUMENTS

Certification file N°59350 Rev.NR dated 2015/04/10. This file includes 14 items (23 pages).



LCIE

1 **ATTESTATION D'EXAMEN DE TYPE
VOLONTAIRE**

2 **Appareil ou composant** destiné à être utilisé en
atmosphères explosibles
(Directive 94/9/CE)



**VOLUNTARY TYPE EXAMINATION
CERTIFICATE**

Equipment or component intended for use in potentially
explosive atmospheres
(Directive 94/9/EC)

3 **Version : 00**

LCIE 15 ATEX 1007 X

Issue : 00

13 **ANNEXE**

SCHEDULE

17 **RECAPITULATIF DES LIMITATIONS**

L'appareil ne doit être raccordé qu'à un équipement dont les paramètres électriques sont compatibles avec les paramètres électriques définis au paragraphe 15.
Température ambiante d'utilisation : - 54°C à +121°C.
L'appareil doit être raccordé conformément au plan n°8072 (page2/2).

SCHEDULE OF LIMITATIONS

The apparatus must be only connected to an equipment whose electrical parameters are compatible with the electrical parameters define clause 15.
Operating ambient temperature : -54°C to +121°C
The apparatus shall be connected according to drawing n°8072 (page 2/2).

18 **EXIGENCES ESSENTIELLES DE SECURITE ET DE SANTE**

Couvertes par les normes listées au point 9.

ESSENTIAL HEALTH AND SAFETY REQUIREMENTS

Covered by standards listed at 9.

19 **INFORMATIONS COMPLEMENTAIRES**

Essais individuels

Chaque exemplaire du matériel devra avoir subi un essai de rigidité diélectrique d'une valeur efficace égale à 600V pendant 100ms sous une tension sinusoïdale de 50 Hz.

ADDITIONAL INFORMATIONS

Routine tests

Each single apparatus must be submitted to a dielectric strength test of 600V r.m.s. during 100ms, with a sine-shaped voltage 50Hz.

20 **DETAILS DES MODIFICATIONS**

Version 00 : version initiale

DETAILS OF CHANGES

Issue 00 : Initial issue



LCIE

ATTESTATION D'EXAMEN UE DE TYPE EU TYPE EXAMINATION CERTIFICATE



1 Version : 04

LCIE 03 ATEX 6114 X

Issue : 04

Directive 2014/34/UE

Directive 2014/34/EU

2 Appareil ou Système de Protection destiné à être utilisé en Atmosphères Explosibles

Equipment or Protective System Intended for use in Potentially Explosive Atmospheres

3 Produit :
Capteurs de vibration

Product :
Vibration sensors

Type: EX(XX)622yzzz/aaa, EX(XX)623yzzz/aaa, EX(XX)625yzzz/aaa, EX(XX)628yzzz/aaa

4 Fabricant :

Manufacturer :

PCB Piezotronics

5 Adresse :

Address :

3425 Walden Avenue
Depew, New York 14043
USA

6 Ce produit et ses variantes éventuelles acceptées sont décrits dans l'annexe de la présente attestation et dans les documents descriptifs cités en référence.

This product and any acceptable variations thereto are specified in the schedule to this certificate and the documents therein referred to.

7 Le LCIE, Organisme Notifié sous la référence 0081 conformément à l'article 17 de la directive 2014/34/UE du Parlement européen et du Conseil du 26 février 2014, certifie que ce produit est conforme aux Exigences Essentielles de Sécurité et de Santé pour la conception et la construction de produits destinés à être utilisés en atmosphères explosibles, données dans l'annexe II de la Directive.

LCIE, Notified Body number 0081 in accordance with article 17 of the Directive 2014/34/EU of the European Parliament and the Council of 26 February 2014 certifies that product has been found to comply with the Essential Health and Safety Requirements relating to the design and construction of products intended for use in potentially explosive atmospheres, given in Annex II to the Directive.

Les résultats des vérifications et essais figurent dans le(s) rapport(s) confidentiel(s) N° :

The examination and test results are recorded in confidential report(s) N°:

41083010, 81562-571183, 127598-655825, 143168-689175, 156608-724493

8 Le respect des Exigences Essentielles de Sécurité et de Santé est assuré par la conformité à :

Compliance with the Essential Health and Safety Requirements has been assured by compliance with :

EN 60079-0:2012 + A11:2013
EN 60079-11: 2012

9 Le signe « X » lorsqu'il est placé à la suite du numéro de l'attestation, indique que cet appareil est soumis aux conditions particulières d'utilisation, mentionnées dans l'annexe de cette attestation.

If the sign "X" is placed after the certificate number, it indicates that the product is subject to the Specific Conditions of Use specified in the schedule to this certificate.

10 Cette Attestation d'Examen UE de Type concerne uniquement la conception et la construction du produit spécifié. Des exigences supplémentaires de la directive sont applicables pour la fabrication et la fourniture du produit. Ces dernières ne sont pas couvertes par la présente attestation.

This EU Type Examination Certificate relates only to the design and construction of the specified product. Further requirements of the Directive apply to the manufacturing process and supply of this product. These are not covered by this certificate.

11 Le marquage du produit est mentionné dans l'annexe de cette attestation.

The marking of the product is specified in the schedule to this certificate.

Fontenay-aux-Roses, le 1er août 2019

Responsable de Certification
Certification Officer

Julien Gauthier

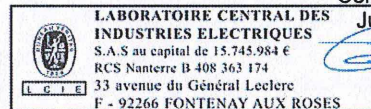

Seul le texte en français peut engager la responsabilité du LCIE. Ce document ne peut être reproduit que dans son intégralité, sans aucune modification. Il est établi en accord avec le référentiel de certification ATEX du LCIE. The LCIE's liability applies only on the French text. This document may only be reproduced in its entirety and without any change. It is issued in accordance with LCIE's ATEX Certification Rules.
CERT-ATEX-FORM 04 Rev. 05

Page 1 / 4

LCIE

Laboratoire Central des Industries Electriques
Une société de Bureau Veritas

33 Avenue du Général Leclerc
92260 Fontenay-aux-Roses
FRANCE

WWW.LCIE.FR

12 DESCRIPTION DU PRODUIT

Les appareils sont des capteurs de vibration utilisant un cristal de quartz pour convertir une mesure de vibration mécanique en un signal électrique.

L'appareil se compose d'une enveloppe métallique cylindrique scellée contenant un circuit imprimé et un élément cristal de quartz, d'un connecteur ou d'un câble intégral pour connexion externe.

DETAIL DE LA GAMME

Les modèles sont électriquement identiques mais mécaniquement différents :

- EX(XX)622yzzz/aaa : Capteur avec connecteur ou câble intégré de sortie dirigée vers le haut
- EX(XX)623yzzz/aaa : Capteur avec connecteur ou câble intégré de sortie dirigée vers le haut
- EX(XX)625yzzz/aaa : Capteur avec connecteur ou câble intégré de sortie latérale
- EX(XX)628yzzz/aaa : Capteur avec connecteur ou câble intégré de sortie dirigée vers le haut

DESCRIPTION OF PRODUCT

The equipment are vibration sensors using a quartz crystal to convert a mechanical vibration measurement into an electric signal.

The equipment consists of a sealed cylindrical metal body which houses a PCB board and a piezo-crystal element, and a connector or an integral cable for external connection.

RANGE DETAILS

Models are electrical identical, but mechanical different:

- EX(XX)622yzzz/aaa: Sensor with top exit connector or integral cable
- EX(XX)623yzzz/aaa: Sensor with top exit connector or integral cable
- EX(XX)625yzzz/aaa: Sensor with side exit connector or integral cable
- EX(XX)628yzzz/aaa: Sensor with top exit connector or integral cable

Symbole Symbol	Description Description	
XX	HT	Accéléromètre à haute température <i>High temperature accelerometer</i>
	M	Câble et matériel de montage métrique <i>Metric mounting hardware and cable</i>
	TO	Capteur de température de sortie <i>Temperature output sensor</i>
	VO	Capteur de vitesse de sortie <i>Velocity output sensor</i>
y	Une lettre A à Z décrivant le niveau de révision <i>One letter A to Z depicts revision level</i>	
zzz	Deux ou trois chiffres 00 à 999 décrivant la sensibilité, le filtrage ou le biais etc. <i>Two or three numbers 00 to 999 depicts sensitivity, filtering or bias etc.</i>	
aaa	Longueur de câble et/ou type de connecteur <i>Cable length and/or connector type</i>	

CARACTERISTIQUES

RATINGS

Séries Series	Modèles Models	Longueur max. de câble Length of cable max	Paramètres de sécurité intrinsèque Intrinsic safety parameters		
Avec connecteur With connector	EX(VO)622yzzz/aaa EX(VO)623yzzz/aaa EX(VO)625yzzz/aaa	/	C _i : 69.2nF, L _i : 0µH	U _i : 28V, I _i : 93mA, P _i : 1W	
	EX(XX)622yzzz/aaa EX(XX)623yzzz/aaa EX(XX)625yzzz/aaa EX(XX)628yzzz/aaa	/	C _i : 6.5nF, L _i : 0µH		
	Avec câble With cable	EX(VO)622yzzz/aaa EX(VO)623yzzz/aaa EX(VO)625yzzz/aaa	61 m (200 ft)		C _i : 81.4nF, L _i : 61µH
		EX(XX)622yzzz/aaa EX(XX)623yzzz/aaa EX(XX)625yzzz/aaa EX(XX)628yzzz/aaa	305 m (1000 ft)		C _i : 67.5nF, L _i : 305µH

Seul le texte en français peut engager la responsabilité du LCIE. Ce document ne peut être reproduit que dans son intégralité, sans aucune modification. Il est établi en accord avec le référentiel de certification ATEX du LCIE. The LCIE's liability applies only on the French text. This document may only be reproduced in its entirety and without any change. It is issued in accordance with LCIE's [ATEX Certification Rules](#).
CERT-ATEX-FORM 04 Rev. 05



ATTESTATION D'EXAMEN UE DE TYPE - ANNEXE

EU TYPE EXAMINATION CERTIFICATE - SCHEDULE

1 Version : 04

LCIE 03 ATEX 6114 X

Issue : 04

MARQUAGE

Le marquage du produit doit comprendre :

Marquage complet :

PCB Piezotronics ou IMI sensors ou IMI
 Adresse : ...
 Type : ... (1)
 N° de fabrication : ...
 Année de fabrication : ...
 LCIE 03 ATEX 6114 X
 $U_i : \dots V, I_i : \dots mA, P_i : \dots W, C_i : \dots nF, L_i : \dots \mu F$ (1)

Pour modèles sans option HT :

⊗ I M1 Ex ia I Ma (-54°C ≤ T_{amb} ≤ +121°C)

Pour modèles avec option HT :

⊗ II 1 G Ex ia IIC T3 Ga (-54°C ≤ T_{amb} ≤ +163°C)

Pour modèles sans option HT :

⊗ II 1 G Ex ia IIC T4 Ga (-54°C ≤ T_{amb} ≤ +121°C)

Marquage réduit :

PCB Piezotronics ou IMI sensors ou IMI
 Type : ... (1)
 N° de fabrication : ...
 Année de fabrication : ...
 LCIE 03 ATEX 6114 X
 $U_i : \dots V, I_i : \dots mA, P_i : \dots W, C_i : \dots nF, L_i : \dots \mu F$ (1)

Pour modèles sans option HT :

⊗ I M1 Ex ia I Ma (-54°C ≤ T_{amb} ≤ +121°C)

Pour modèles avec option HT :

⊗ II 1 G Ex ia IIC T3 Ga (-54°C ≤ T_{amb} ≤ +163°C)

Pour modèles sans option HT :

⊗ II 1 G Ex ia IIC T4 Ga (-54°C ≤ T_{amb} ≤ +121°C)

(1) : à compléter selon modèles

L'appareil doit également comporter le marquage normalement prévu par les normes de construction qui le concernent sous la responsabilité du fabricant.

13 CONDITIONS PARTICULIERES D'UTILISATION

- L'appareil ne peut être raccordé qu'à des équipements certifiés de sécurité intrinsèque. Ces associations doivent être répondre aux exigences de la sécurité intrinsèque.
- L'appareil doit être raccordé conformément aux instructions du constructeur (voir plan 65040).
- L'appareil doit être mis à la terre conformément à la norme EN 60079-0.

MARKING

The marking of the product shall include the following :

Complete marking:

PCB Piezotronics or IMI Sensors or IMI
 Address: ...
 Type: ... (1)
 Serial number: ...
 Year of construction: ...
 LCIE 03 ATEX 6114 X
 $U_i : \dots V, I_i : \dots mA, P_i : \dots W, C_i : \dots nF, L_i : \dots \mu F$ (1)

For models without HT option:

⊗ I M1 Ex ia I Ma (-54°C ≤ T_{amb} ≤ +121°C)

For models with HT option :

⊗ II 1 G Ex ia IIC T3 Ga (-54°C ≤ T_{amb} ≤ +163°C)

For models without HT option:

⊗ II 1 G Ex ia IIC T4 Ga (-54°C ≤ T_{amb} ≤ +121°C)

Reduced marking:

PCB Piezotronics or IMI Sensors or IMI
 Type: ... (1)
 Serial number: ...
 Year of construction: ...
 LCIE 03 ATEX 6114 X
 $U_i : \dots V, I_i : \dots mA, P_i : \dots W, C_i : \dots nF, L_i : \dots \mu F$ (1)

For models without HT option:

⊗ I M1 Ex ia I Ma (-54°C ≤ T_{amb} ≤ +121°C)

For models with HT option :

⊗ II 1 G Ex ia IIC T3 Ga (-54°C ≤ T_{amb} ≤ +163°C)

For models without HT option:

⊗ II 1 G Ex ia IIC T4 Ga (-54°C ≤ T_{amb} ≤ +121°C)

(1) : to be completed following models

The equipment shall also bear the usual marking required by the product standards applying to such equipment under the manufacturer responsibility.

SPECIFIC CONDITIONS OF USE

- The equipment must only be connected to certified intrinsically safe equipment. These combinations must be compatible as regard intrinsic safety rules.
- The equipment shall be connected in accordance with the manufacturer's installation instructions (see drawing 65040).
- The equipment shall be earthed in accordance with EN 60079-0.

Seul le texte en français peut engager la responsabilité de LCIE. Ce document ne peut être reproduit que dans son intégralité, sans aucune modification. Il est établi en accord avec le référentiel de certification ATEX du LCIE. The LCIE's liability applies only on the French text. This document may only be reproduced in its entirety and without any change. It is issued in accordance with LCIE's ATEX Certification Rules.
 CERT-ATEX-FORM 04 Rev. 05

Page 3 / 4

LCIE

Laboratoire Central des Industries Electriques
 Une société de Bureau Veritas

33 Avenue du Général Leclerc
 92260 Fontenay-aux-Roses
 FRANCE

WWW.LCIE.FR



ATTESTATION D'EXAMEN UE DE TYPE - ANNEXE

EU TYPE EXAMINATION CERTIFICATE - SCHEDULE

1 Version : 04

LCIE 03 ATEX 6114 X

Issue : 04

14 EXIGENCES ESSENTIELLES DE SANTE ET DE SECURITE

ESSENTIAL HEALTH AND SAFETY REQUIREMENTS

Couvertes par les normes listées au point 8.

Covered by standards listed at 8.

15 DOCUMENTS DESCRIPTIFS

DESCRIPTIVE DOCUMENTS

N°	Description	Reference	Rev.	Date	Page(s)
1.	Instructions	32241	-	-	3
2.	Technical file	65002	A	2018/12/14	44

16 INFORMATIONS COMPLEMENTAIRES

ADDITIONAL INFORMATION

Essais individuels

Routine tests

Néant

None

Conditions de certification

Conditions of certification

Les détenteurs d'attestations d'examen UE de type doivent également satisfaire les exigences de contrôle de production telles que définies à l'article 13 de la Directive 2014/34/UE.

Holders of EU type examination certificates are also required to comply with the production control requirements defined in article 13 of Directive 2014/34/EU.

17 DETAILS DES MODIFICATIONS DE L'ATTESTATION

DETAILS OF CERTIFICATE CHANGES

Version 00 : Evaluation de la conformité selon les normes
22/05/2003 EN 50014:1997 + amendement 1 à 2,
EN 50020:2002 et EN 50284:994.

Issue 00: Conformity assessment according to EN
2003/05/22 50014:1997 + amendments 1 to 2, EN
50020:2002 and EN 50284:1994 standards.

Version 01 : Mise à jours normative selon les normes
29/07/2008 EN 60079-0:2004 et EN 60079-11:2007.

Issue 01: Normative update according to
2008/07/29 EN 60079-0:2004 and EN 60079-11:2007.

Version 02 : - Mise à jour normative selon les normes
05/05/2015 EN 60079-0:2012+A11:2013 et EN 60079-
11:2012.
- Ajout des modèles EX622B0X, EX622B1X,
EXVO622B0X, EXVO622B1X et EX622C1X.

Issue 02: - Normative update according to EN 60079-
2015/05/05 0:2012 + A11:2013 and EN 60079-11:2012
standards.
- Addition of models EX622B0X, EX622B1X,
EXVO622B0X, EXVO622B1X and
EX622C1X.

- Suppression des modèles EX622A31, EX628F31
et EXVO622A31.
- Modifications des paramètres électriques.

- Removal of models EX622A31, EX628F31
and EXVO622A31.
- Modification of the electrical parameters.

Version 03 : - Ajout d'un nouveau modèle EX(XX)625xyyy/aaa.
20/02/2017 - Ajout d'une nouvelle option de sortie de
température.
- Mise à jour de la nomenclature des modèles.
- Distinction entre le nom du fabricant (PCB
Piezotronic) et le nom de la marque commerciale
(IMI sensors ou IMI).

Issue 03: - Addition of new model EX(XX)625xyyy/aaa.
2017/02/20 - Addition of new option of temperature output.

- Update of the nomenclature of the models.
- Distinction between the name of the
manufacturer (PCB Piezotronics) and the
name of the trademark (IMI sensors or IMI).

Version 04 : - Correction de la plage de température et de la
actuelle classe de température pour les modèles Haute
Température (HT)
- Ajout de la certification pour les Mines
grisouteuses

Issue 04: - For High Temperature (HT) model:
current correction of temperature range and
temperature class.
- Addition of Mine safety protection.

Seul le texte en français peut engager la responsabilité du LCIE. Ce document ne peut être reproduit que dans son intégralité, sans aucune modification. Il est établi en accord avec le référentiel de certification ATEX du LCIE. The LCIE's liability applies only on the French text. This document may only be reproduced in its entirety and without any change. It is issued in accordance with LCIE's [ATEX Certification Rules](#).
CERT-ATEX-FORM 04 Rev. 05

Page 4 / 4

LCIE

Laboratoire Central des Industries Electriques
Une société de Bureau Veritas

33 Avenue du Général Leclerc
92260 Fontenay-aux-Roses
FRANCE

WWW.LCIE.FR



LCIE

ATTESTATION D'EXAMEN UE DE TYPE EU TYPE EXAMINATION CERTIFICATE



1 Version : 03

LCIE 03 ATEX 6114 X

Issue : 03

Directive 2014/34/UE

Directive 2014/34/EU

2 Appareil ou Système de Protection destiné à être utilisé en Atmosphères Explosibles

Equipment or Protective System Intended for use in Potentially Explosive Atmospheres

3 Produit :
Capteurs de vibration

Product :
Vibration sensors

Type: EX(XX)622yzzz/aaa, EX(XX)623yzzz/aaa, EX(XX)625yzzz/aaa, EX(XX)628yzzz/aaa

4 Fabricant :

Manufacturer :

PCB Piezotronics

5 Adresse :

Address :

3425 Walden Avenue
Depew, New York 14043
USA

6 Ce produit et ses variantes éventuelles acceptées sont décrits dans l'annexe de la présente attestation et dans les documents descriptifs cités en référence.

This product any acceptable variation thereto is specified in the schedule to this certificate and the documents therein referred to.

7 Le LCIE, Organisme Notifié sous la référence 0081 conformément à l'article 17 de la directive 2014/34/UE du Parlement européen et du Conseil du 26 février 2014, certifie que ce produit est conforme aux Exigences Essentielles de Sécurité et de Santé pour la conception et la construction de produits destinés à être utilisés en atmosphères explosibles, données dans l'annexe II de la Directive.
Les résultats des vérifications et essais figurent dans le(s) rapport(s) confidentiel(s) N° :

LCIE, Notified Body number 0081 in accordance with article 17 of the Directive 2014/34/EU of the European Parliament and the Council of 26 February 2014 certifies that product has been found to comply with the Essential Health and Safety Requirements relating to the design and construction of products intended for use in potentially explosive atmospheres, given in Annex II to the Directive.

The examination and test results are recorded in confidential report(s) N°:

41083010, 81562-571183, 127598-655825, 143168-689175.

8 Le respect des Exigences Essentielles de Sécurité et de Santé est assuré par la conformité à :

Compliance with the Essential Health and Safety Requirements has been assured by compliance with :

EN 60079-0:2012 + A11:2013, EN 60079-11:2012

9 Le signe « X » lorsqu'il est placé à la suite du numéro de l'attestation, indique que cet appareil est soumis aux conditions particulières d'utilisation, mentionnées dans l'annexe de cette attestation.

If the sign "X" is placed after the certificate number, it indicates that the product is subject to the Specific Conditions of Use specified in the schedule to this certificate.

10 Cette Attestation d'Examen UE de Type concerne uniquement la conception et la construction du produit spécifié.
Des exigences supplémentaires de la directive sont applicables pour la fabrication et la fourniture du produit. Ces dernières ne sont pas couvertes par la présente attestation.

This EU Type Examination Certificate relates only to the design and construction of the specified product.
Further requirements of the Directive apply to the manufacturing process and supply of this product. These are not covered by this certificate.

11 Le marquage du produit est mentionné dans l'annexe de cette attestation.

The marking of the product is specified in the schedule to this certificate.

Fontenay-aux-Roses, le 21 février 2017

Responsable des Opérations de Certification
Manager of Certification Operations
Didier Bourges



Seul le texte en français peut engager la responsabilité du LCIE. Ce document ne peut être reproduit que dans son intégralité, sans aucune modification. Il est établi en accord avec le référentiel de certification ATEX du LCIE. The LCIE's liability applies only on the French text. This document may only be reproduced in its entirety and without any change. It is issued in accordance with LCIE's ATEX Certification Rules.
CERT-ATEX-FORM 04 Rev. 02

Page 1 of 4

LCIE

Laboratoire Central des Industries Electriques
Une société de Bureau Veritas

33 Avenue du Général Leclerc
92260 Fontenay-aux-Roses
FRANCE

WWW.LCIE.FR



ATTESTATION D'EXAMEN UE DE TYPE - ANNEXE

EU TYPE EXAMINATION CERTIFICATE - SCHEDULE

1 Version : 03

LCIE 03 ATEX 6114 X

Issue : 03

12 DESCRIPTION DU PRODUIT

Les capteurs de vibration type EX(XX)622yzzz/aaa, EX(XX)623yzzz/aaa, EX(XX)625yzzz/aaa ou EX(XX)628yzzz/aaa utilisent un cristal de quartz pour convertir une mesure de vibration mécanique en un signal électrique.

Le capteur se compose d'un boîtier métallique cylindrique scellé, qui abrite une carte de substrat PCB et un élément piézo-cristal, et un connecteur ou un câble intégré pour raccordement externe.

Paramètres électriques :

DESCRIPTION OF PRODUCT

The vibration sensors type EX(XX)622yzzz/aaa, EX(XX)623yzzz/aaa, EX(XX)625yzzz/aaa or EX(XX)628yzzz/aaa utilise a quartz crystal to convert a mechanical vibration measurement into an electric signal.

The sensor consists of a sealed cylindrical metal case, which houses a PCB substrate board and a piezo-crystal element, and a connector or an integral cable for external connection.

Electrical parameters:

Séries / Series	Modèles / Models	Paramètres de SI / IS parameters	
Avec connecteur With connector	EX(XX)622yzzz/aaa EX(XX)623yzzz/aaa EX(XX)628yzzz/aaa	C_i : 6.5nF, L_i : 0µH	U_i : 28V, I_i : 93mA, P_i : 1W
	EX(XX)625yzzz/aaa	C_i : 9nF, L_i : 0µH	
	EX(VO)622yzzz/aaa EX(VO)623yzzz/aaa	C_i : 69.2nF, L_i : 0µH	
	EX(VO)625yzzz/aaa	C_i : 71.7nF, L_i : 0µH	
Avec câble With cable	EX(XX)622yzzz/aaa EX(XX)623yzzz/aaa	C_i : 67.5nF, L_i : 305µH*	
	EX(XX)628yzzz/aaa	C_i : 61nF, L_i : 305µH*	
	EX(XX)625yzzz/aaa	C_i : 70nF, L_i : 305µH*	
	EX(VO)622yzzz/aaa EX(VO)623yzzz/aaa	C_i : 81.4nF, L_i : 61µH**	

* Longueur du câble / Cable length: 305 m (1000ft)

** Longueur du câble / Cable length: 61m (200ft)

DETAIL DE LA GAMME

Les modèles sont électriquement identiques, mais mécaniquement différents:

EX(XX)622yzzz/aaa: Capteur avec connecteur ou câble intégré de sortie dirigée vers le haut.

EX(XX)623yzzz/aaa: Capteur avec connecteur ou câble intégré de sortie dirigée vers le haut.

EX(XX)625yzzz/aaa: Capteur avec connecteur ou câble intégré de sortie latérale.

EX(XX)628yzzz/aaa: Capteur avec connecteur ou câble intégré de sortie dirigée vers le haut.

RANGE DETAILS

Models are electrically identical, but mechanically different:

EX(XX)622yzzz/aaa: Sensor with top exit connector or integral cable.

EX(XX)623yzzz/aaa: Sensor with top exit connector or integral cable.

EX(XX)625yzzz/aaa: Sensor with side exit connector or integral cable.

EX(XX)628yzzz/aaa: Sensor with top exit connector or integral cable.

Symbole / Symbol	Détail / Detail	
XX	HT	Accéléromètre à haute température High temperature accelerometer
	M	Câble et matériel de montage métrique Metric mounting hardware and cable
	TO	Capteur de température de sortie Temperature output sensor
	VO	Capteur de vitesse de sortie Velocity output sensor
y	Une lettre de A à Z One letter A to Z	
zzz	Deux ou trois chiffres de 00 à 999 Two or three numbers 00 to 999	
aaa	Longueur de câble et/ou type de connecteur Cable length and/or connector type	

Seul le texte en français peut engager la responsabilité du LCIE. Ce document ne peut être reproduit que dans son intégralité, sans aucune modification. Il est établi en accord avec le référentiel de certification ATEX du LCIE. The LCIE's liability applies only on the French text. This document may only be reproduced in its entirety and without any change. It is issued in accordance with LCIE's ATEX Certification Rules.
CERT-ATEX-FORM 04 Rev. 02

Page 2 of 4

LCIE

Laboratoire Central des Industries Electriques
Une société de Bureau Veritas

33 Avenue du Général Leclerc
92260 Fontenay-aux-Roses
FRANCE

WWW.LCIE.FR



ATTESTATION D'EXAMEN UE DE TYPE - ANNEXE EU TYPE EXAMINATION CERTIFICATE - SCHEDULE

1 Version : 03

LCIE 03 ATEX 6114 X

Issue : 03

MARQUAGE

Le marquage du produit doit comprendre :

Marquage complet :

PCB Piezotronics ou IMI sensors ou IMI

Adresse : ...

Type : ...

N° de fabrication : ...

Année de fabrication : ...

II 1 G

Ex ia IIC T4 Ga

LCIE 03 ATEX 6114 X

$-54^{\circ}\text{C} \leq T_{\text{amb}} \leq +121^{\circ}\text{C}$

$U_i : \dots\text{V}, I_i : \dots\text{mA}, P_i : \dots\text{W}, C_i : \dots\text{nF}, L_i : \dots\ \mu\text{F}$

(complété suivant le modèle)

Marquage réduit :

PCB Piezotronics ou IMI sensors ou IMI

Type : ...

N° de fabrication : ...

Année de fabrication : ...

II 1 G

Ex ia IIC T4 Ga

LCIE 03 ATEX 6114 X

$-54^{\circ}\text{C} \leq T_{\text{amb}} \leq +121^{\circ}\text{C}$

$U_i : \dots\text{V}, I_i : \dots\text{mA}, P_i : \dots\text{W}, C_i : \dots\text{nF}, L_i : \dots\ \mu\text{F}$

(complété suivant le modèle)

L'appareil doit également comporter le marquage normalement prévu par les normes de construction qui le concernent sous la responsabilité du fabricant.

13 CONDITIONS PARTICULIERES D'UTILISATION

- a. L'appareil doit être raccordé à des équipements certifiés de sécurité intrinsèque. Ces associations doivent être compatibles vis-à-vis de la sécurité intrinsèque (voir les paramètres électriques).
- b. Température ambiante de fonctionnement : -54°C à $+121^{\circ}\text{C}$.
- c. L'appareil doit être raccordé conformément au manuel d'instruction.

14 EXIGENCES ESSENTIELLES DE SANTE ET DE SECURITE

Couvertes par les normes listées au point 8.

15 DOCUMENTS DESCRIPTIFS

N°	Description	Reference	Rev.	Date	Page(s)
1.	Instructions	32241	C	2016/09/11	3
2.	Technical file	65002	NR	2016/09/02	46

MARKING

The marking of the product shall include the following :

Full marking:

PCB Piezotronics or IMI sensors or IMI

Address: ...

Type: ...

Serial number: ...

Year of construction: ...

II 1 G

Ex ia IIC T4 Ga

LCIE 03 ATEX 6114 X

$-54^{\circ}\text{C} \leq T_{\text{amb}} \leq +121^{\circ}\text{C}$

$U_i : \dots\text{V}, I_i : \dots\text{mA}, P_i : \dots\text{W}, C_i : \dots\text{nF}, L_i : \dots\ \mu\text{F}$

(completed following the model)

Reduced marking:

PCB Piezotronics or IMI sensors or IMI

Type: ...

Serial number: ...

Year of construction: ...

II 1 G

Ex ia IIC T4 Ga

LCIE 03 ATEX 6114 X

$-54^{\circ}\text{C} \leq T_{\text{amb}} \leq +121^{\circ}\text{C}$

$U_i : \dots\text{V}, I_i : \dots\text{mA}, P_i : \dots\text{W}, C_i : \dots\text{nF}, L_i : \dots\ \mu\text{F}$

(completed following the model)

The equipment shall also bear the usual marking required by the product standards applying to such equipment under the manufacturer responsibility.

SPECIFIC CONDITIONS OF USE

The apparatus must be only connected to a certified associated intrinsically safe equipment. This combination must be compatible regarding intrinsic safety rules (see electrical parameters).

Operating ambient temperature: -54°C to $+121^{\circ}\text{C}$.

The apparatus must be connected according to instruction manual.

ESSENTIAL HEALTH AND SAFETY REQUIREMENTS

Covered by standards listed at 8.

DESCRIPTIVE DOCUMENTS

Seul le texte en français peut engager la responsabilité du LCIE. Ce document ne peut être reproduit que dans son intégralité, sans aucune modification. Il est établi en accord avec le [référentiel de certification ATEX](#) du LCIE. The LCIE's liability applies only on the French text. This document may only be reproduced in its entirety and without any change. It is issued in accordance with LCIE's [ATEX Certification Rules](#).
CERT-ATEX-FORM 04 Rev. 02



ATTESTATION D'EXAMEN UE DE TYPE - ANNEXE

EU TYPE EXAMINATION CERTIFICATE - SCHEDULE

1 Version : 03

LCIE 03 ATEX 6114 X

Issue : 03

16 INFORMATIONS COMPLEMENTAIRES

Essais individuels

Néant.

Conditions de certification

Les détenteurs d'attestations d'examen UE de type doivent également satisfaire les exigences de contrôle de production telles que définies à l'article 13 de la Directive 2014/34/UE.

En accord avec l'Article 41 de la Directive 2014/34/UE, les attestations d'examen CE de type mentionnant la Directive 94/9/CE émises avant la date d'application de la Directive 2014/34/UE (20 avril 2016) peuvent être considérées comme émises en accord avec la Directive 2014/34/UE. Les nouvelles versions de ces attestations peuvent conserver le numéro de l'attestation d'origine émise avant le 20 avril 2016.

17 DETAILS DES MODIFICATIONS

Version 00 : Evaluation initial selon les normes
22/05/2003 EN 50014 :1997 + amendement 1 à 2,
EN 50020 : 2002 et EN 50284 :1994.

Version 01 : Mise à jours normative selon les normes
29/07/2008 EN 60079-0:2004 et EN 60079-11:2007.

Version 02 :
05/05/2015

- Mise à jour normative selon les normes EN 60079-0:2012+A11:2013 et EN 60079-11:2012.
- Ajout des modèles EX622B0X, EX622B1X, EXVO622B0X, EXVO622B1X et EX622C1X.
- Suppression des modèles EX622A31, EX628F31 et EXVO622A31.
- Modifications des paramètres électriques.

Version 03 :

- Ajout d'un nouveau modèle EX(XX)625xyyy/aaa.
- Ajout d'une nouvelle option de sortie de température.
- Mise à jour de la nomenclature des modèles.
- Distinction entre le nom du fabricant (PCB Pizotronic) et le nom de la marque commerciale (IMI sensors ou IMI).

ADDITIONAL INFORMATIONS

Routine tests

None.

Conditions of certification

Holders of EU type examination certificates are also required to comply with the production control requirements defined in article 13 of Directive 2014/34/EU.

In accordance with Article 41 of Directive 2014/34/EU, EC-Type Examination Certificates referring to Directive 94/9/EC that were in existence prior to the date of application of Directive 2014/34/EU (20 April 2016) may be referenced as if they were issued in accordance with Directive 2014/34/EU. New issues of such certificates may continue to bear the original certificate number issued prior to 20 April 2016.

DETAILS OF CHANGES

Issue 00: Initial assessment according to EN 50014:1997
2003/05/22 + amendments 1 to 2, EN 50020: 2002 and EN 50284:1994 standards.

Issue 01: Normative update according to
2008/07/29 EN 60079-0:2004 and EN 60079-11:2007.

Issue 02:
2015/05/05

- Normative update according to EN 60079-0:2012 + A11:2013 and EN 60079-11:2012 standards.
- Addition of models EX622B0X, EX622B1X, EXVO622B0X, EXVO622B1X and EX622C1X.
- Cancelling models EX622A31, EX628F31 and EXVO622A31.
- Modification of the electrical parameters.

Issue 03:

- Adding a new model EX(XX)625xyyy/aaa.
- Addition a new option of temperature output.
- Update of the nomenclature of the models.
- Distinction between the name of the manufacturer (PCB Piezotronics) and the name of the trademark (IMI sensors or IMI).

Seul le texte en français peut engager la responsabilité du LCIE. Ce document ne peut être reproduit que dans son intégralité, sans aucune modification. Il est établi en accord avec le [référentiel de certification ATEX](#) du LCIE. The LCIE's liability applies only on the French text. This document may only be reproduced in its entirety and without any change. It is issued in accordance with LCIE's [ATEX Certification Rules](#).
CERT-ATEX-FORM 04 Rev. 02

Page 4 of 4

LCIE

Laboratoire Central des Industries Electriques
Une société de Bureau Veritas

33 Avenue du Général Leclerc
92260 Fontenay-aux-Roses
FRANCE

WWW.LCIE.FR



LCIE

1 AVENANT D'ATTESTATION D'EXAMEN CE DE TYPE

2 Appareil ou système de protection destiné à être utilisé en atmosphères explosibles (Directive 94/9/CE)

3 Numéro de l'avenant : LCIE 03 ATEX 6114 X / 02

4 Appareil ou système de protection : Capteurs de vibration
Type : EX622 series, EX623 series, EX628 series, EXVO622 series

5 Demandeur : I.M.I
A PCB Piezotronics Div.

15 DESCRIPTION DE L'AVENANT

Mise à jour normative selon les normes EN 60079-0:2012 +A11:2013 et EN 60079-11:2012
Ajout des modèles EX622B0X, EX622B1X, EXVO622B0X, EXVO622B1X et EX622C1X.
Suppression des modèles EX622A31, EX628F31 et EXVO622A31.
Modifications des paramètres électriques.

Les résultats des vérifications et essais figurent dans le rapport confidentiel N°127598-655825.

Paramètres spécifiques du ou des modes de protection concerné(s) :
Modifiés comme suit :

Table with 6 columns: Type, Ui (V), Ii (mA), Pi (W), Ci (nF), Li (µH). Rows include models like EX622A0X, EX622B0X, EX623C0X, EX628F0X, EXVO622B0X, EXVO622A0X, EX622A1X, EX622B1X, EX623C1X, EXVO622A1X, EXVO622B1X, EX628F1X.

(1) longueur du câble 304,78m
(2) longueur du câble 60,95m

Le marquage doit être : Modifié comme suit :
IMI Sensors
Adresse : ...
Type : EX6... ou EXVO6... (complété avec le modèle)
N° de fabrication : ...
Année de fabrication : ...
II 1 G
Ex ia IIC T4 Ga
LCIE 03 ATEX 6114 X
-54°C ≤ Ta ≤ +121°C
Ui : ... V, Ii : ... mA, Pi : ... W, Ci : ... nF, Li : ... µH (complété suivant le modèle)

Fontenay-aux-Roses, le 5 mai 2015

1 SUPPLEMENTARY EC TYPE EXAMINATION CERTIFICATE

2 Equipment or protective system intended for use in potentially explosive atmospheres (Directive 94/9/EC)

3 Supplementary certificate number : LCIE 03 ATEX 6114 X / 02

4 Equipment or protective system : Vibration sensors
Type : EX622 series, EX623 series, EX628 series, EXVO622 series

5 Applicant : I.M.I
A PCB Piezotronics Div.

15 DESCRIPTION OF THE SUPPLEMENTARY CERTIFICATE

Normative update according to EN 60079-0:2012 + A11:2013 and EN 60079-11:2012 standards.
Adding models EX622B0X, EX622B1X, EXVO622B0X, EXVO622B1X and EX622C1X.
Cancelled models EX622A31, EX628F31 and EXVO622A31.
Modification of the electrical parameters.

The examination and test results are recorded in confidential report N°127598-655825.

Specific parameters of the concerned protection mode:
Modified as follows :

(1) cable length 1000 FT
(2) cable length 200FT

The marking shall be : Modified as follows :
IMI Sensors
Address :
Type : EX6... or EXVO6... (completed with the model)
Serial number : ...
Year of construction : ...
II 1 G
Ex ia IIC T4 Ga
LCIE 03 ATEX 6114 X
-54°C ≤ Ta ≤ +121°C
Ui : ... V, Ii : ... mA, Pi : ... W, Ci : ... nF, Li : ... µH (completed following the model)

Le Responsable de Certification ATEX
ATEX Certification Officer
Julien Gauthier

Seul le texte en français peut engager la responsabilité du LCIE. Ce document ne peut être reproduit que dans son intégralité, sans aucune modification.
The LCIE's liability applies only on the French text. This document may only be reproduced in its entirety and without any change.



13 ANNEXE

14 AVENANT D'ATTESTATION D'EXAMEN CE DE TYPE

LCIE 03 ATEX 6114 X / 02

16 DOCUMENTS DESCRIPTIFS

Dossier de certification N°22142 rév.B du 10/04/2015
Ce dossier comprend 14 rubriques (23 pages).

17 CONDITIONS SPECIALES POUR UNE UTILISATION SURE

Modifiées comme suit :
L'appareil ne peut être raccordé qu'à un matériel associé de sécurité intrinsèque certifié. Cette association doit être compatible vis-à-vis de la sécurité intrinsèque (voir les paramètres électriques).
Température ambiante d'utilisation : -54°C à +121°C.
L'appareil doit être raccordé conformément au plan n°8072 (page 1/2).

18 EXIGENCES ESSENTIELLES DE SECURITE ET DE SANTE

Couvertes par les normes EN 60079-0:2012 + A11:2013 et EN 60079-11:2012.

19 VERIFICATIONS ET ESSAIS INDIVIDUELS

Néant.

13 SCHEDULE

14 SUPPLEMENTARY EC TYPE EXAMINATION CERTIFICATE

LCIE 03 ATEX 6114 X / 02

16 DESCRIPTIVE DOCUMENTS

Certification file N°22142 rev.B dated 2015/04/10.
This file includes 14 items (23 pages).

17 SPECIAL CONDITIONS FOR SAFE USE

Modified as follows :
The apparatus must be only connected to a certified associated intrinsically safe equipment. This combination must be compatible regarding intrinsic safety rules (see electrical parameters).
Operating ambient temperature : - 54°C to + 121°C.
The apparatus shall be connected according to drawing n°8072 (page 1/2).

18 ESSENTIAL HEALTH AND SAFETY REQUIREMENTS

Covered by EN 60079-0:2012 + A11:2013 and EN 60079-11:2012 standards.

19 ROUTINE VERIFICATIONS AND TESTS

None.



L C I E

- | | |
|--|---|
| <p>1 AVENANT D'ATTESTATION D'EXAMEN CE DE TYPE</p> <p>2 Appareil ou système de protection destiné à être utilisé en atmosphères explosibles (Directive 94/9/CE)</p> <p>3 Numéro de l'avenant :
LCIE 03 ATEX 6114 X / 01</p> <p>4 Appareil ou système de protection :
Capteurs de vibrations
Type : EX622A01, EX622A11, EX622A31,
EX628F01, EX628F11, EX628F31,
EXVO622A01, EXVO622A11,
EXVO622A31, EX623C00 ou EX623C01</p> <p>5 Demandeur : Industrial Monitoring Instrumentation (I.M.I.)</p> <p>15 DESCRIPTION DE L'AVENANT
Mise à jour normative selon les normes EN 60079-0 (2004) et EN 60079-11 (2007).
Les résultats des vérifications et essais figurent dans le rapport confidentiel N° 81562-571183.
<u>Paramètres spécifiques du ou des modes de protection concerné(s) :</u>
Inchangés
<u>Le marquage doit être modifié et complété comme suit :</u>
Ex ia IIC T4
$U_i \leq \dots, I_i \leq \dots, P_i \leq \dots, L_i \leq \dots, C_i \leq \dots$
$U_o \leq 28 \text{ V}, I_o \leq 93 \text{ mA}, P_o \leq 0,8 \text{ W}$</p> <p>16 DOCUMENTS DESCRIPTIFS
Dossier de certification N° 22142 Rév. A du 25/07/2008. Ce dossier comprend 27 rubriques (42 pages).</p> <p>17 CONDITIONS SPECIALES POUR UNE UTILISATION SURE
Inchangées</p> <p>18 EXIGENCES ESSENTIELLES DE SECURITE ET DE SANTE
Couvertes par les normes EN 60079-0 (2004) et EN 60079-11 (2007).</p> <p>19 VERIFICATIONS ET ESSAIS INDIVIDUELS
Néant</p> | <p>1 SUPPLEMENTARY EC TYPE EXAMINATION CERTIFICATE</p> <p>2 Equipment or protective system intended for use in potentially explosive atmospheres (Directive 94/9/EC)</p> <p>3 Supplementary certificate number :
LCIE 03 ATEX 6114 X / 01</p> <p>4 Equipment or protective system :
Vibrations sensors
Type : EX622A01, EX622A11, EX622A31,
EX628F01, EX628F11, EX628F31,
EXVO622A01, EXVO622A11,
EXVO622A31, EX623C00 ou EX623C01</p> <p>5 Applicant : Industrial Monitoring Instrumentation (I.M.I.)</p> <p>15 DESCRIPTION OF THE SUPPLEMENTARY CERTIFICATE
Normative update according to EN 60079-0 (2004) and EN 60079-11 (2007).
The examination and test results are recorded in confidential report N° 81562-571183.
<u>Specific parameters of the mode(s) of protection concerned:</u>
Unchanged
<u>The marking shall be modified and completed as follows :</u>
Ex ia IIC T4
$U_i \leq \dots, I_i \leq \dots, P_i \leq \dots, L_i \leq \dots, C_i \leq \dots$
$U_o \leq 28 \text{ V}, I_o \leq 93 \text{ mA}, P_o \leq 0,8 \text{ W}$</p> <p>16 DESCRIPTIVE DOCUMENTS
Certification file N° 22142 Rev. A dated 25/07/2008. This file includes 27 items (42 pages).</p> <p>17 SPECIAL CONDITIONS FOR SAFE USE
Unchanged</p> <p>18 ESSENTIAL HEALTH AND SAFETY REQUIREMENTS
Covered by standards EN 60079-0 (2004) and EN 60079-11 (2007).</p> <p>19 ROUTINE VERIFICATIONS AND TESTS
None</p> |
|--|---|

Fontenay-aux-Roses, le 29 juillet 2008

Le responsable de certification ATEX
ATEX certification manager

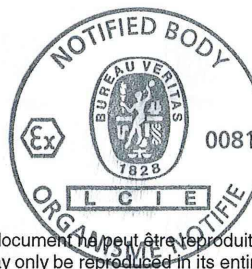

pd Cervello
Henri CERVELLO

Seul le texte en français peut engager la responsabilité du LCIE. Ce document ne peut être reproduit que dans son intégralité, sans aucune modification.
The LCIE's liability applies only on the French text. This document may only be reproduced in its entirety and without any change.



L C I E

1 ATTESTATION D'EXAMEN CE DE TYPE

2 Appareils et systèmes de protection destinés à être utilisés en atmosphères explosibles

Directive 94/9/CE

3 Numéro de l'attestation d'examen CE de type

LCIE 03 ATEX 6114 X

4 Appareil ou système de protection :

Capteurs de vibrations

Type : EX622A01, EX622A11, EX622A31, EX628F01, EX628F11, EX628F31, EXVO622A01, EXVO622A11, EXVO622A31, EX623C00 ou EX623C01

5 Demandeur : Industrial Monitoring Instrumentation (I.M.I.)

6 Adresse : 3425 Walden Avenue
Depew, New York
14043 USA

7 Cet appareil ou système de protection et ses variantes éventuelles acceptées est décrit dans l'annexe de la présente attestation et dans les documents descriptifs cités en annexe.

8 Le LCIE, organisme notifié sous la référence 0081 conformément à l'article 9 de la directive 94/9/CE du Parlement européen et du Conseil du 23 mars 1994, certifie que cet appareil ou système de protection est conforme aux exigences essentielles en ce qui concerne la sécurité et la santé pour la conception et la construction d'appareils et de systèmes de protection destinés à être utilisés en atmosphères explosibles, données dans l'annexe II de la directive. Les vérifications et épreuves figurent dans notre rapport confidentiel N°41083010.

9 Le respect des exigences essentielles en ce qui concerne la sécurité et la santé est assuré par la conformité aux documents suivants :

- EN 50014 (1997) + amendements 1 à 2
- EN 50020 (2002),
- EN 50284 (1999).

10 Le signe X lorsqu'il est placé à la suite du numéro de l'attestation, indique que ce matériel ou système de protection est soumis aux conditions spéciales pour une utilisation sûre, mentionnées dans l'annexe de la présente attestation.

11 Cette attestation d'examen CE de type concerne uniquement la conception et la construction de l'appareil ou du système de protection spécifié, conformément à la directive 94/9/CE. Des exigences supplémentaires de cette directive sont applicables pour la fabrication et la fourniture de l'appareil ou du système de protection.

12 Le marquage de l'appareil ou du système de protection devra comporter, entre autres indications utiles, les mentions suivantes :

Ex II 1 G
EEx ia IIC T4

Fontenay-aux-Roses, le 22 mai 2003

1 EC TYPE EXAMINATION CERTIFICATE

2 Equipment or protective system intended for use in potentially explosive atmospheres

Directive 94/9/EC

3 EC type Examination Certificate number

LCIE 03 ATEX 6114 X

4 Equipment or protective system :

Vibrations sensors

Type : EX622A01, EX622A11, EX622A31, EX628F01, EX628F11, EX628F31, EXVO622A01, EXVO622A11, EXVO622A31, EX623C00 or EX623C01

5 Applicant : Industrial Monitoring Instrumentation (I.M.I.)

6 Address : 3425 Walden Avenue
Depew, New York
14043 USA

7 This equipment or protective system and any acceptable variation thereto is specified in the schedule to this certificate and the documents therein referred to.

8 LCIE, notified body number 0081 in accordance with article 9 of the Directive 94/9/EC of the European Parliament and Council of 23 March 1994, certifies that this equipment or protective system has been found to comply with the essential Health and Safety Requirements relating to the design and construction of equipment and protective system intended for use in potentially explosive atmospheres, given in Annex II of the Directive. The examination and test results are recorded in confidential report No. 41083010.

9 Compliance with the Essential Health and Safety Requirements has been assured by compliance with :

- EN 50014 (1997) + amendments 1 to 2
- EN 50020 (2002),
- EN 50284 (1999).

10 If the sign X is placed after the certificate number, it indicates that the equipment or protective system is subject to special conditions for safe use specified in the schedule to this certificate.

11 This EC Type examination certificate relates only to the design and construction of this specified equipment or protective system in accordance with the Directive 94/9/EC. Further requirements of the Directive applies to the manufacture and supply of this equipment or protective system.

12 Marking of the equipment or protective system shall include the following :

Ex II 1 G
EEx ia IIC T4

Le Directeur de l'organisme certificateur
Manager of the certification body

Henri Cervello
Timbre sec / Dry seal

Seul le texte en français peut engager la responsabilité du LCIE. Ce document ne peut être reproduit que dans son intégralité, sans aucune modification
The LCIE's liability applies only on the French text. This document may be reproduced in full and without any change



L C I E

(A1) ANNEXE

(A1) SCHEDULE

(A2) ATTESTATION D'EXAMEN CE DE TYPE

(A2) EC TYPE EXAMINATION CERTIFICATE

LCIE 03 ATEX 6114 X

LCIE 03 ATEX 6114 X

(A3) Description de l'équipement ou du système de protection :

(A3) Description of Equipment or Protective System :

Capteurs de vibrations
Type : EX622A01, EX622A11, EX622A31,
EX628F01, EX628F11, EX628F31,
EXVO622A01, EXVO622A11, EXVO622A31
EX623C00 ou EX623C01

Vibration sensors
Type : EX622A01, EX622A11, EX622A31,
EX628F01, EX628F11, EX628F31,
EXVO622A01, EXVO622A11, EXVO622A31
EX623C00 or EX623C01

Le matériel (construit en acier inoxydable) est composé d'un ensemble piézo-cristal, d'une carte électronique et d'un connecteur ou d'un câble.

The apparatus (made in stainless steel) is formed of a piezo-crystal assembly, an electronic board and a connector or a cable.

Le marquage est le suivant :

Marking is as following :

Industrial Monitoring Instrumentation
Adresse
Type : EX622A01, EX622A11, EX622A31, EX628F01,
EX628F11, EX628F31, EXVO622A01, EXVO622A11,
EXVO622A31, EX623C00 ou EX623C01
N° de fabrication : ...
Année de construction : ...
 II 1 G
EEx ia IIC T4
LCIE 03 ATEX 6114 X

Industrial Monitoring Instrumentation
Address
Type : EX622A01, EX622A11, EX622A31, EX628F01,
EX628F11, EX628F31, EXVO622A01, EXVO622A11,
EXVO622A31, EX623C00 or EX623C01
Serial number : ...
Year of manufacturing : ...
 II 1 G
EEx ia IIC T4
LCIE 03 ATEX 6114 X

Le marquage CE est accompagné du numéro d'identification de l'organisme notifié responsable de la surveillance du système approuvé de qualité (0081 pour le LCIE).

The CE marking shall be accompanied by the identification number of the notified body responsible for surveillance of the approved quality system (0081 for LCIE).

Le matériel devra également comporter le marquage normalement prévu par les normes de construction du matériel électrique concerné.

The equipment must also carry the usual marking required by the manufacturing standards applying to such equipments.

Paramètres spécifiques du ou des modes de protection concerné(s) :

Specific parameters of the concerned protective mode(s) :

Type / Type	Ui (V)	Ii (mA)	Pi (W)	Li (µH)	Ci (nF)	Longueur du câble / Cable length (m)
EX622A01 EX622A31 EX628F01 EX628F31 EX623C00 EX623C01	28	93	0,8	0	1,2	Modèles sans câble / Models without cable
EXVO622A01 EXVO622A31				0	62	Modèles sans câble / Models without cable
EX622A11 EX628F11				151	26,2	305
EXVO622A11				76	74,5	152

(A4) Documents descriptifs :

(A4) Descriptive documents :

Dossier technique N°22142 Rév. NR daté du 7 Mai 2003.
Ce document comprend 27 rubriques (42 pages).

Technical file No. 22142 Rev. NR dated May 7th, 2003.
This file includes 27 items (42 pages).



L C I E

(A1) ANNEXE

(A1) SCHEDULE

(A2) ATTESTATION D'EXAMEN CE DE TYPE

(A2) EC TYPE EXAMINATION CERTIFICATE

LCIE 03 ATEX 6114 X (suite)

LCIE 03 ATEX 6114 X (continued)

(A5) Conditions spéciales pour une utilisation sûre :

(A5) Special conditions for safe use :

Le matériel ne doit être raccordé qu'à un matériel associé de sécurité intrinsèque certifié et cette association doit être compatible du point de vue de la sécurité intrinsèque.

The apparatus must be only connected to a certified associated intrinsically safe equipment and this combination must be compatible as regards intrinsic safety rules.

Les caractéristiques électriques du matériel associé de sécurité intrinsèque ne doivent excéder aucune des valeurs suivantes :
 $U_0 \leq 28 \text{ V}$, $I_0 \leq 93 \text{ mA}$, $P_0 \leq 0,8 \text{ W}$

The electrical parameters of the associated intrinsically safe equipment must not exceed any of the following values :
 $U_0 \leq 28 \text{ V}$, $I_0 \leq 93 \text{ mA}$, $P_0 \leq 0,8 \text{ W}$

Température ambiante d'utilisation : - 54°C à + 121°C

Ambient operating temperature : - 54°C to + 121°C

Lorsque l'appareil est équipé d'un câble, le raccordement devra être effectué dans une enveloppe IP20 minimum.

When the equipment is used with a cable, it shall be connected with a minimum IP20 enclosure.

(A6) Exigences essentielles en ce qui concerne la sécurité et la santé :

(A6) Essential Health and Safety Requirements:

Conformité aux normes européennes EN 50014 (1997 + amendements 1 et 2), EN 50020 (2002) et EN 50284 (1999).

Conformity to the European standards EN 50014 (1997 + amendments 1 and 2), EN 50020 (2002) and EN 50284 (1999).

Vérifications et épreuves individuelles :

Individual examinations and tests :

Néant.

None.

EU Declaration of Conformity PS061
In Accordance with ISO/IEC 17050

Manufacturer: PCB Piezotronics, Inc. 3425 Walden Avenue Depew, New York 14043 USA	Authorized European Representative: PCB Piezotronics Europe GmbH Porschestrasse 20-30 41836 Hückelhoven, Germany
--	---

Certifies that type of equipment: ICP® Vibration Sensor(s)

Whose Product Models Include: EX(XX)622yzzz/aaa, EX(XX)623yzzz/aaa, EX(XX)625yzzz/aaa, EX(XX)628yzzz/aaa

Where:

- (XX) - Represents one or more optional designations including:
 - HT - High Temperature Accelerometer (325°F)
 - M Metric mounting hardware and cable
 - TO - Temperature Output Sensor
 - VO - Velocity Output Sensor
- y – Represents one Letter A to Z
- zzz – Represents two or three Numbers 00 to 999
- aaa - Designates cable length and/or connector type

This declaration is applicable to all Vibration Sensor(s) of the above series which have the CE & (EX) ATEX mark on their data sheets and where those data sheets refer to this declaration of conformity. The data sheets for all model numbers referenced above, which include the CE & (EX) ATEX mark on such data sheets and refer to this Declaration of Conformity are hereby incorporated by reference into this Declaration.

Conform to the following EU Directive(s) when installed per product documentation:	2014/30/EU	EMC Directive
	2014/34/EU	ATEX Directive
	2011/65/EU w/2015/863/EU	RoHS Directive

Standards to which Conformity is Declared:

Harmonized Standards	EN 61326-1:2013	Electrical Equipment for Measurement, Control and Laboratory Use- EMC Requirements – Part 1: General Requirements
	EN 61326-2-3:2013	Electrical Equipment for Measurement, Control and Laboratory Use- EMC Requirements – Part 2-3: Particular Requirements
	EN 60079-0:2012 +A11:2013	Explosive Atmospheres – Part 0: Equipment – General Requirements
	EN 60079-11:2012	Explosive Atmospheres – Part 11: Equipment Protection by Intrinsic Safety “i”
	EN 60079-26:2007	Explosive Atmospheres – Part 26: Equipment with Equipment Protection Level (EPL) Ga
	EN 63000:2018	Technical documentation for the assessment of electrical and electronic products with respect to the restriction of hazardous substances
Emissions Test Standards	EN 55011:2009+ A1:2010	Industrial, Scientific and Medical Equipment - Radio frequency Disturbance Characteristics - Limits and Methods of Measurement
Other Standards Applied (non-OJEU)	EN 61000-6-1:2007	Electromagnetic Compatibility (EMC) - Generic standards — Immunity for residential, commercial and light-industrial environments
	EN 61000-6-2:2005	Electromagnetic compatibility (EMC) — Part 6-2: Generic standards — Immunity for industrial environments
Immunity Test Standards		Explosive Atmospheres

Test Reports	EMC Reports Safety Reports	GM29028c, GM29030c, GM29045c GM29029s, GM29031s, GM29046s
EC Type Examination	ATEX Certification	LCIE 03 ATEX 6114 X Ex ia IIC T4 Ga, II 1 G
Voluntary Certification	Voluntary Type Examination Certificate	LCIE 15 ATEX 1007 X Ex nA IIC T4 Gc, II 3 G
Other International Certifications	IECEX Certification	IECEX LCIE 15.0016X Ex ia IIC T4 Ga Ex nA IIC T4 Gc
Notified Body Name		Laboratoire Central des Industries Electriques (0081)
Notified Body's Address		FONTENAY-AUX-ROSES (Head Office) 33, avenue du Général Leclerc FR- 92260 Fontenay-aux-Roses Tel. : + 33 1 40 95 60 60 Fax : + 33 1 40 95 86 56

I, the undersigned, hereby declare that the equipment specified above conforms to the above Directive(s) Standard(s)

Place: Depew, NY
Date: 07/02/2021

Signature:



Name: Carrie Termin

Title: Regulatory Affairs and Product Certification Specialist



IECEX Certificate of Conformity

INTERNATIONAL ELECTROTECHNICAL COMMISSION IEC Certification Scheme for Explosive Atmospheres

for rules and details of the IECEx Scheme visit www.iecex.com

Certificate No.: IECEx LCIE 15.0016X

Issue No: 3

Certificate history:

Status: **Current**

Issue No. 3 (2019-08-01)

Issue No. 2 (2017-02-24)

Date of Issue: **2019-08-01**

Page 1 of 4

Issue No. 1 (2015-11-09)

Issue No. 0 (2015-05-05)

Applicant: **PCB Piezotronics**
3425 Walden Avenue
Depew, New York 14043
United States of America

Equipment: **Vibration sensors - Type: EX(XX)622yzzz/aaa, EX(XX)623yzzz/aaa, EX(XX)625yzzz/aaa, EX(XX)628yzzz/aaa**

Optional accessory:

Type of Protection: **Ex ia, Ex nA**

Marking:

- Ex ia IIC T4 Ga (for models without HT option)
 - Ex ia IIC T3 Ga (for models with HT option)
 - Ex ia I Ma (for model EX(XX)625yzzz/aaa without HT option)
 - Ex nA IIC T4 Gc (for models without HT option)
 - Ex nA IIC T3 Gc (for models with HT option)
- (Refer to attachment for full marking)

Approved for issue on behalf of the IECEx
Certification Body:

Julien Gauthier

Position:

Certification Officer

Signature:
(for printed version)



Date:

2019-08-01

1. This certificate and schedule may only be reproduced in full.
2. This certificate is not transferable and remains the property of the issuing body.
3. The Status and authenticity of this certificate may be verified by visiting the [Official IECEx Website](http://www.iecex.com).

Certificate issued by:

Laboratoire Central des Industries Electriques (LCIE)
33 Avenue du General Leclerc
FR-92260 Fontenay-aux-Roses
France





IECEX Certificate of Conformity

Certificate No: IECEX LCIE 15.0016X

Issue No: 3

Date of Issue: **2019-08-01**

Page 2 of 4

Manufacturer: **PCB Piezotronics**
3425 Walden Avenue
Depew, New York 14043
United States of America

Additional Manufacturing location(s):
PCB Piezotronics of North Carolina Inc.
10869 Hwy 903
Halifax, NC 27839
United States of America

This certificate is issued as verification that a sample(s), representative of production, was assessed and tested and found to comply with the IEC Standard list below and that the manufacturer's quality system, relating to the Ex products covered by this certificate, was assessed and found to comply with the IECEx Quality system requirements. This certificate is granted subject to the conditions as set out in IECEx Scheme Rules, IECEx 02 and Operational Documents as amended.

STANDARDS:

The apparatus and any acceptable variations to it specified in the schedule of this certificate and the identified documents, was found to comply with the following standards:

IEC 60079-0 : 2011 Edition:6.0	Explosive atmospheres - Part 0: General requirements
IEC 60079-11 : 2011 Edition:6.0	Explosive atmospheres - Part 11: Equipment protection by intrinsic safety "i"
IEC 60079-15 : 2010 Edition:4	Explosive atmospheres - Part 15: Equipment protection by type of protection "n"

*This Certificate **does not** indicate compliance with electrical safety and performance requirements other than those expressly included in the Standards listed above.*

TEST & ASSESSMENT REPORTS:

A sample(s) of the equipment listed has successfully met the examination and test requirements as recorded in

Test Report:

FR/LCIE/ExTR15.0017/00

FR/LCIE/ExTR15.0115/00

FR/LCIE/ExTR17.0008/00

FR/LCIE/ExTR19.0067/00

FR/LCIE/ExTR19.0071/00

Quality Assessment Report:

NL/DEK/QAR14.0004/03



IECEX Certificate of Conformity

Certificate No: IECEx LCIE 15.0016X

Issue No: 3

Date of Issue: 2019-08-01

Page 3 of 4

Schedule

EQUIPMENT:

Equipment and systems covered by this certificate are as follows:

The equipment are vibration sensors using a quartz crystal to convert a mechanical vibration measurement into an electric signal.

The equipment consists of a sealed cylindrical metal body which houses a PCB board and a piezo-crystal element, and a connector or an integral cable for external connection.

SPECIFIC CONDITIONS OF USE: YES as shown below:

For intrinsic safety Ia:

- a) The equipment must only be connected to certified intrinsically safe equipment. These combinations must be compatible as regard intrinsic safety rules.
- b) The equipment shall be connected in accordance with the manufacturer's installation instructions (see drawing 65040).
- c) The equipment shall be earthed in accordance with IEC 60079-0.

For non sparking nA:

- a) The apparatus must be only connected to an equipment whose electrical parameters are compatible with the electrical parameters.
- b) The equipment shall be connected in accordance with the manufacturer's installation instructions (see drawing 65040).
- c) For final installation, the device shall be connected in compliance with IEC 60079-14 requirements, providing and maintaining degree of protection at least IP54 according to IEC 60079-0 requirements.
- d) Provision shall be made, external to the equipment, to provide the transient protection device to be set at a level not exceeding 119 V.
- e) The equipment shall be earthed in accordance with IEC 60079-0.
- f) WARNING – DO NOT SEPARATE WHEN ENERGIZED.



IECEx Certificate of Conformity

Certificate No: IECEx LCIE 15.0016X

Issue No: 3

Date of Issue: 2019-08-01

Page 4 of 4

DETAILS OF CERTIFICATE CHANGES (for issues 1 and above):

Issue 01:

- Modification of the QAR.
- Addition of a manufacturing site.

Issue 02:

- Addition of a new model (EX(XX)625xyyy/aaa).
- Addition of a new temperature output.
- Update of the nomenclature of the models.
- Distinction between the name of the manufacturer (PCB Piezotronics) and the name of the trademark (IMI sensors or IMI).

Issue 03:

- For High Temperature (HT) model: correction of temperature range and temperature class.
- Addition of Mine safety in intrinsically safe protection mode.

Annex

[LCIE 15.0016X - Issue03 - Annex 01.pdf](#)



Annex 01 to Certificate IECEX LCIE 15.0016X issue 03



L C I E

FULL EQUIPMENT DESCRIPTION

The equipment are vibration sensors using a quartz crystal to convert a mechanical vibration measurement into an electric signal. The sensor consists of a sealed cylindrical metal body which houses a PCB board and a piezo-crystal element, and a connector or an integral cable for external connection.

Instruction manual: ref. 32241

MARKING

For intrinsic safety ia:

Complete marking:

PCB Piezotronics or IMI Sensors or IMI

Address: ...

Type: ... (1)

Serial number: ...

Year of construction: ...

IECEX LCIE 15.0016X

$U_i : \dots V, I_i : \dots mA, P_i : \dots W, C_i : \dots nF, L_i : \dots \mu F$ (1)

For EX(XX)625yzzz/aaa models without HT option:

For models with HT option:

For models without HT option:

Ex ia I Ma $(-54^{\circ}C \leq T_{amb} \leq +121^{\circ}C)$

Ex ia IIC T3 Ga $(-54^{\circ}C \leq T_{amb} \leq +163^{\circ}C)$

Ex ia IIC T4 Ga $(-54^{\circ}C \leq T_{amb} \leq +121^{\circ}C)$

Reduced marking:

PCB Piezotronics or IMI Sensors or IMI

Type: ... (1)

Serial number: ...

Year of construction: ...

IECEX LCIE 15.0016X

$U_i : \dots V, I_i : \dots mA, P_i : \dots W, C_i : \dots nF, L_i : \dots \mu F$ (1)

For EX(XX)625yzzz/aaa models without HT option:

For models with HT option:

For models without HT option:

Ex ia I Ma $(-54^{\circ}C \leq T_{amb} \leq +121^{\circ}C)$

Ex ia IIC T3 Ga $(-54^{\circ}C \leq T_{amb} \leq +163^{\circ}C)$

Ex ia IIC T4 Ga $(-54^{\circ}C \leq T_{amb} \leq +121^{\circ}C)$

(1) : to be completed following models

For non sparking nA:

Complete marking :

PCB Piezotronics or IMI sensors or IMI

Address: ...

Type: ... (1)

Serial number: ...

Year of construction: ...

Ex nA IIC T3 Gc $(-54^{\circ}C \leq T_{amb} \leq +163^{\circ}C)$ for models with HT option

Ex nA IIC T4 Gc $(-54^{\circ}C \leq T_{amb} \leq +121^{\circ}C)$ for models without HT option

IECEX LCIE 15.0016X

$U \leq 28V, I \leq 93mA, P \leq 1W$

WARNING - DO NOT SEPARATE WHEN ENERGIZED

Reduced marking:

PCB Piezotronics or IMI sensors or IMI

Type: ... (1)

Serial number: ...

Year of construction: ...

Ex nA IIC T3 Gc $(-54^{\circ}C \leq T_{amb} \leq +163^{\circ}C)$ for models with HT option

Ex nA IIC T4 Gc $(-54^{\circ}C \leq T_{amb} \leq +121^{\circ}C)$ for models without HT option

IECEX LCIE 15.0016X

$U \leq 28V, I \leq 93mA, P \leq 1W$

(1) : to be completed following models



Annex 01 to Certificate IECEX LCIE 15.0016X issue 03



L C I E

RANGE DETAILS

Models are electrically identical, but mechanical different:

- EX(XX)622yzzz/aaa with top exit connector or integral cable
- EX(XX)623yzzz/aaa with top exit connector or integral cable
- EX(XX)625yzzz/aaa with side exit connector or integral cable
- EX(XX)628yzzz/aaa with top exit connector or integral cable

Nomenclature:

Symbol	Description	
XX	HT	High temperature accelerometer
	M	Metric mounting hardware and cable
	TO	Temperature output sensor
	VO	Velocity output sensor
y	One letter A to Z depicts revision level	
zzz	Two or three numbers 00 to 999 depicts sensitivity, filtering or bias etc.	
aaa	Cable length and/or connector type	

RATINGS

For intrinsic safety ia:

Series	Models	Length of cable max	Intrinsic safety parameters	
With connector	EX(VO)622yzzz/aaa EX(VO)623yzzz/aaa EX(VO)625yzzz/aaa	/	$C_i : 69.2nF, L_i : 0\mu H$	$U_i : 28V, I_i : 93mA, P_i : 1W$
	EX(XX)622yzzz/aaa EX(XX)623yzzz/aaa EX(XX)625yzzz/aaa EX(XX)628yzzz/aaa	/	$C_i : 6.5nF, L_i : 0\mu H$	
With cable	EX(VO)622yzzz/aaa EX(VO)623yzzz/aaa EX(VO)625yzzz/aaa	61 m (200 ft)	$C_i : 81.4nF, L_i : 61\mu H$	
	EX(XX)622yzzz/aaa EX(XX)623yzzz/aaa EX(XX)625yzzz/aaa EX(XX)628yzzz/aaa	305 m (1000 ft)	$C_i : 67.5nF, L_i : 305\mu H$	

For non sparking nA:

$U \leq 28 V, I \leq 93 mA, P \leq 1 W$

FULL CONDITIONS OF CERTIFICATION

For intrinsic safety ia:

- a) The equipment must only be connected to certified intrinsically safe equipment. These combinations must be compatible as regard intrinsic safety rules.
- b) The equipment shall be connected in accordance with the manufacturer's installation instructions (see drawing 65040).
- c) The equipment shall be earthed in accordance with EN/IEC 60079-0.

For non sparking nA:

- a) The apparatus must be only connected to an equipment whose electrical parameters are compatible with the electrical parameters.
- b) The equipment shall be connected in accordance with the manufacturer's installation instructions (see drawing 65040).
- c) For final installation, the device shall be connected in compliance with EN/IEC 60079-14 requirements, providing and maintaining degree of protection at least IP54 according to EN/IEC 60079-0 requirements.
- d) Provision shall be made, external to the equipment, to provide the transient protection device to be set at a level not exceeding 119 V.
- e) The equipment shall be earthed in accordance with EN/IEC 60079-0.
- f) **WARNING – DO NOT SEPARATE WHEN ENERGIZED.**

ROUTINE TESTS

For intrinsic safety ia:

None

For non sparking nA:

Each apparatus must be submitted to a dielectric strength 600V 50Hz applied during 100ms between the terminals and the housing.

APPARATUS OVERVIEW

Approved models form :

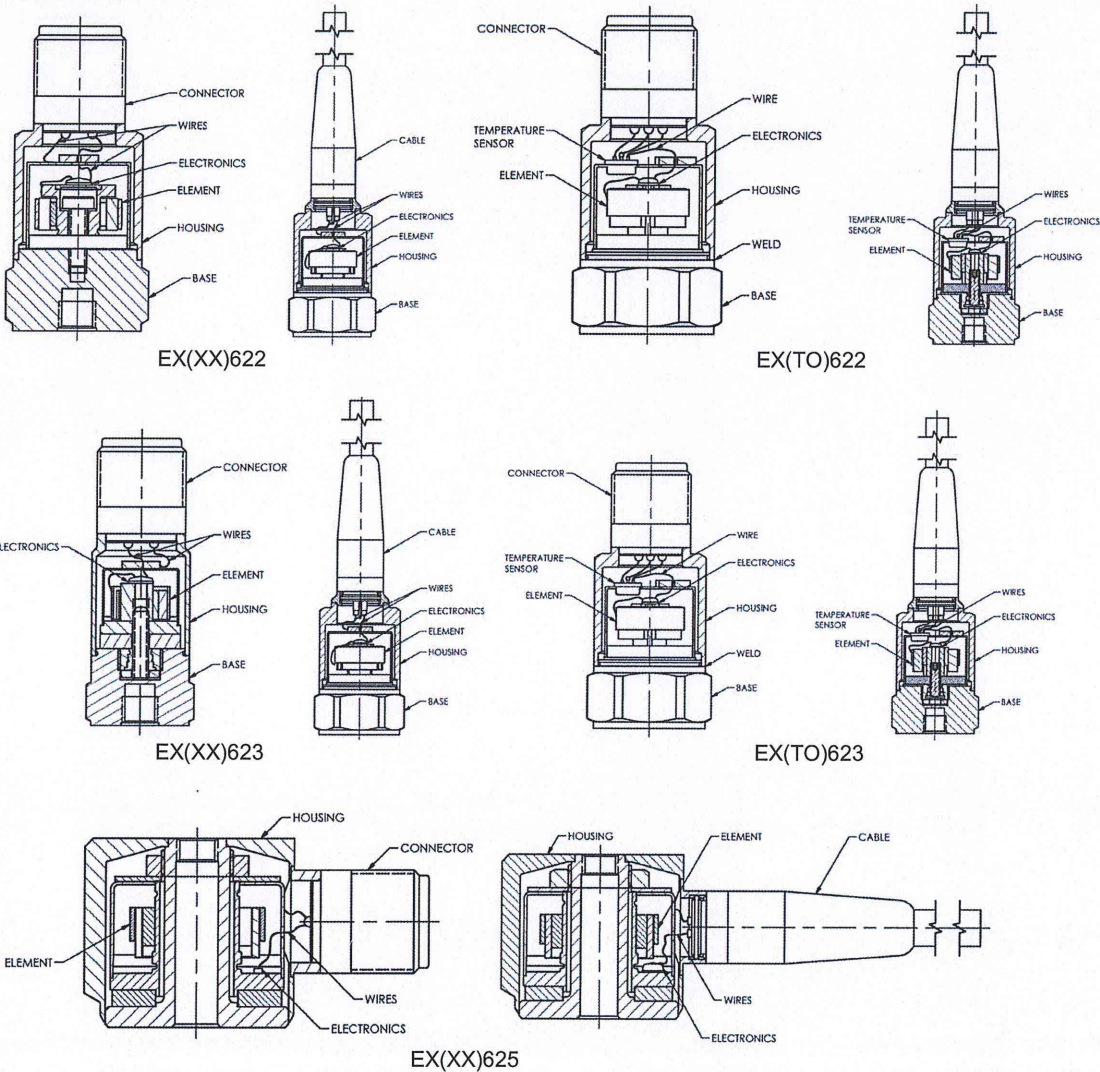

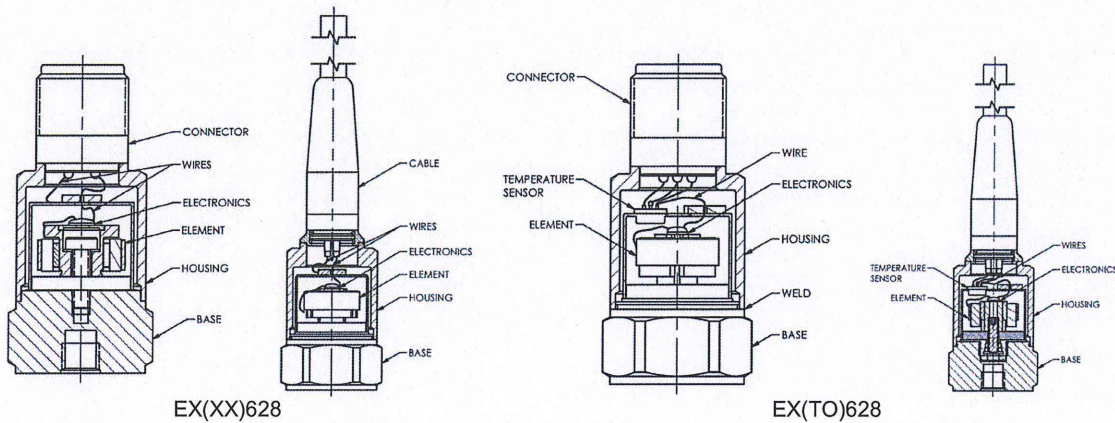
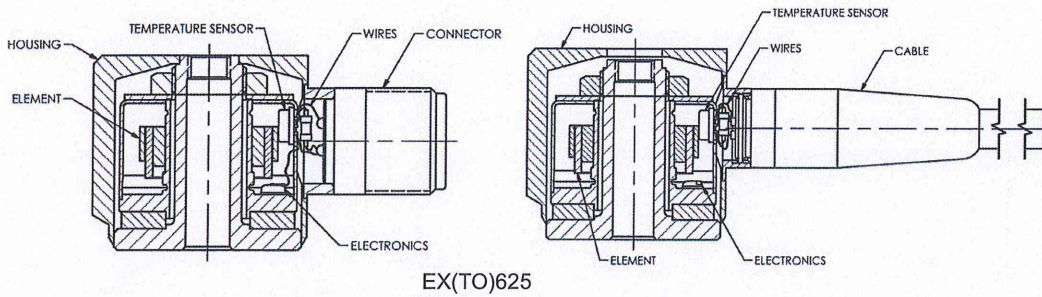

TEST & ASSESSMENT REPORTS

A sample(s) of the equipment listed has successfully met the examination and test requirements as recorded in

Test Report:

FR/LCI/ExTR19.0067/00
FR/LCI/ExTR19.0071/00

Quality Assessment Report:

NL/DEK/QAR14.0004/03

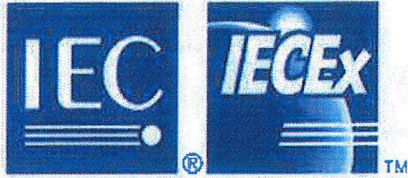

IECEx Certificate of Conformity

INTERNATIONAL ELECTROTECHNICAL COMMISSION IEC Certification Scheme for Explosive Atmospheres

for rules and details of the IECEx Scheme visit www.iecex.com

Certificate No.: **IECEx LCIE 15.0016X** issue No.: **2**
Status: **Current**
Date of Issue: **2017-02-24** Page 1 of 4

Certificate history:
Issue No. 2 (2017-2-24)
Issue No. 1 (2015-11-9)
Issue No. 0 (2015-5-5)

Applicant: **PCB Piezotronics**
3425 Walden Avenue
Depew, New York 14043
United States of America

Equipment: **Vibration sensors - Type: EX(XX)622yzzz/aaa, EX(XX)623yzzz/aaa, EX(XX)625yzzz/aaa, EX(XX)628yzzz/aaa**
Optional accessory:

Type of Protection: **Ex ia, Ex nA**

Marking: **Ex ia IIC T4 Ga**
Ex nA IIC T4 Gc

(Refer to attachment for full marking)

Approved for issue on behalf of the IECEx
Certification Body:

Didier BOURGES

Position:

Manager of Certification Operations

Signature:
(for printed version)

Date:

24 FEB. 2017

1. This certificate and schedule may only be reproduced in full.
2. This certificate is not transferable and remains the property of the issuing body.
3. The Status and authenticity of this certificate may be verified by visiting the Official IECEx Website.

Certificate issued by:

Laboratoire Central des Industries Electriques (LCIE)
33 Avenue du General Leclerc
FR-92260 Fontenay-aux-Roses
France

Documents relative to LCIE certification activities (Certificates, QARs, ExTRs) can be registered under the references "LCI" or "LCIE".





IECEX Certificate of Conformity

Certificate No.: IECEX LCIE 15.0016X

Date of Issue: 2017-02-24

Issue No.: 2

Page 2 of 4

Manufacturer: **PCB Piezotronics**
3425 Walden Avenue
Depew, New York 14043
United States of America

Additional Manufacturing location(s):

**PCB Piezotronics of
North Carolina Inc.**
10869 Hwy 903
Halifax, NC 27839
United States of America

This certificate is issued as verification that a sample(s), representative of production, was assessed and tested and found to comply with the IEC Standard list below and that the manufacturer's quality system, relating to the Ex products covered by this certificate, was assessed and found to comply with the IECEx Quality system requirements. This certificate is granted subject to the conditions as set out in IECEx Scheme Rules, IECEx 02 and Operational Documents as amended.

STANDARDS:

The electrical apparatus and any acceptable variations to it specified in the schedule of this certificate and the identified documents, was found to comply with the following standards:

IEC 60079-0 : 2011 Edition: 6.0	Explosive atmospheres - Part 0: General requirements
IEC 60079-11 : 2011 Edition: 6.0	Explosive atmospheres - Part 11: Equipment protection by intrinsic safety "I"
IEC 60079-15 : 2010 Edition: 4	Explosive atmospheres - Part 15: Equipment protection by type of protection "n"

*This Certificate **does not** indicate compliance with electrical safety and performance requirements other than those expressly included in the Standards listed above.*

TEST & ASSESSMENT REPORTS:

A sample(s) of the equipment listed has successfully met the examination and test requirements as recorded in

Test Report:

FR/LCIE/ExTR15.0017/00

FR/LCIE/ExTR15.0115/00

FR/LCIE/ExTR17.0008/00

Quality Assessment Report:

NL/DEK/QAR14.0004/01



IECEX Certificate of Conformity

Certificate No.: IECEx LCIE 15.0016X

Date of Issue: 2017-02-24

Issue No.: 2

Page 3 of 4

Schedule

EQUIPMENT:

Equipment and systems covered by this certificate are as follows:

The vibration sensors type EX(XX)622yzzz/aaa, EX(XX)623yzzz/aaa, EX(XX)625yzzz/aaa or EX(XX)628yzzz/aaa used a quartz crystal to convert a mechanical vibration measurement into an electric signal.

The sensor consists of a sealed cylindrical metal case, which houses a PCB substrate board and a piezo-crystal element, and a connector or an integral cable for external connection.

SPECIFIC CONDITIONS OF USE: YES as shown below:

Version "ja":

- The apparatus must be only connected to a certified associated intrinsically safe equipment. This combination must be compatible regarding intrinsic safety rules (see electrical parameters).
- Operating ambient temperature: - 54°C to + 121°C.
- The apparatus must be connected according to instruction manual.

Version "nA":

- The apparatus must be only connected to an equipment whose electrical parameters are compatible with the electrical parameters.
- For final installation, the device shall be connected in compliance with IEC 60079-14 requirements, providing and maintaining degree of protection at least IP54.
- Operating ambient temperature: -54°C to +121°C.
- The apparatus must be connected according to instruction manual.
- WARNING - DO NOT SEPARATE WHEN ENERGIZED.



Annex 00 to Certificate IECEX LCIE 15.0016X issue 02



RANGE DETAILS

Models are electrically identical, but mechanically different :

- EX(XX)622yzzz/aaa: Sensor with top exit connector or integral cable
- EX(XX)623yzzz/aaa: Sensor with top exit connector or integral cable
- EX(XX)625yzzz/aaa: Sensor with side exit connector or integral cable
- EX(XX)628yzzz/aaa: Sensor with top exit connector or integral cable

Nomenclature:

Symbol	Detail	
XX	HT	High temperature accelerometer
	M	Metric mounting hardware and cable
	TO	Temperature output sensor
	VO	Velocity output sensor
y	One letter A to Z depicts revision level	
zzz	Two or three numbers 00 to 999 depicts sensitivity, filtering or bias etc.	
aaa	Cable length and/or connector type	

RATINGS

Version "ia":

Series	Models	IS parameters	$U_i : 28V,$ $I_i : 93mA,$ $P_i : 1W$
With connector	EX(XX)622yzzz/aaa	$C_i : 6.5nF, L_i : 0\mu H$	
	EX(XX)623yzzz/aaa		
	EX(XX)628yzzz/aaa		
	EX(XX)625yzzz/aaa	$C_i : 9nF, L_i : 0\mu H$	
	EX(VO)622yzzz/aaa	$C_i : 69.2nF, L_i : 0\mu H$	
	EX(VO)623yzzz/aaa		
With cable	EX(VO)625yzzz/aaa	$C_i : 71.7nF, L_i : 0\mu H$	
	EX(XX)622yzzz/aaa	$C_i : 67.5nF, L_i : 305\mu H^*$	
	EX(XX)623yzzz/aaa		
	EX(XX)628yzzz/aaa		
	EX(XX)625yzzz/aaa	$C_i : 61nF, L_i : 305\mu H^*$	
	EX(VO)622yzzz/aaa	$C_i : 70nF, L_i : 305\mu H^*$	
EX(VO)623yzzz/aaa	$C_i : 81.4nF, L_i : 61\mu H^{**}$		

* Cable length: 305 m (1000ft)

** Cable length: 61m (200ft)

Version "nA":

$U \leq 28V, I \leq 93mA, P \leq 1W$

ROUTINE TESTS

Version "ia": None.

Version "nA": Each apparatus must be submitted to a dielectric strength 600V 50Hz during 100ms between the terminals and the housing.



IECEX Certificate of Conformity

Certificate No.: IECEx LCIE 15.0016X

Date of Issue: 2017-02-24

Issue No.: 2

Page 4 of 4

DETAILS OF CERTIFICATE CHANGES (for issues 1 and above):

Issue 01:

- Modification of the QAR.
- Addition of a manufacturing site

Issue 02:

- Addition of a new model EX(XX)625xyyy/aaa.
- Addition of a new option of temperature output.
- Update of the nomenclature of the models.
- Distinction between the name of the manufacturer (PCB Piezotronics) and the name of the trademark (IMI sensors or IMI).

Annex: LCIE 15.0016x issue02-Annex00.pdf



Annex 00 to Certificate IECEX LCIE 15.0016X issue 02



FULL EQUIPMENT DESCRIPTION

The vibration sensors type EX(XX)622yzzz/aaa, EX(XX)623yzzz/aaa, EX(XX)625yzzz/aaa or EX(XX)628yzzz/aaa utilise a quartz crystal to convert a mechanical vibration measurement into an electric signal.

The sensor consists of a sealed cylindrical metal case, which houses a PCB substrate board and a piezo-crystal element, and a connector or an integral cable for external connection.

Instruction manual:

N°	Description	Reference	Rev.	Date	Page(s)
1.	Instructions for use	32241	C	2016/09/11	3

MARKING

Version "ia":

PCB Piezotronic or IMI Sensors or IMI

Address: ...

Type: ...

Serial number: ...

Year of construction: ...

Ex ia IIC T4 Ga

IECEX LCIE 15.0016X

-54°C ≤ T_{amb} ≤ +121°C

U_i: ...V, I_i: ...mA, P: ...W, C_i: ...nF, L_i: ...µF (completed with electrical parameters)

Equipment has a reduced marking:

PCB Piezotronic or IMI Sensors or IMI

Type: ...

Serial number: ...

Year of construction: ...

Ex ia IIC T4 Ga

IECEX LCIE 15.0016X

-54°C ≤ T_{amb} ≤ +121°C

U_i: ...V, I_i: ...mA, P: ...W, C_i: ...nF, L_i: ...µF (completed with electrical parameters)

Version "nA":

PCB Piezotronic or IMI Sensors or IMI

Address: ...

Type: ...

Serial number: ...

Year of construction: ...

Ex nA IIC T4 Gc

IECEX LCIE 15.0016X

-54°C ≤ T_{amb} ≤ +121°C

WARNING - DO NOT SEPARATE WHEN ENERGIZED

Equipment has a reduced marking:

PCB Piezotronic or IMI Sensors or IMI

Type: ...

Serial number: ...

Year of construction: ...

Ex nA IIC T4 Gc

IECEX LCIE 15.0016X

-54°C ≤ T_{amb} ≤ +121°C



IECEX Certificate of Conformity

INTERNATIONAL ELECTROTECHNICAL COMMISSION IEC Certification Scheme for Explosive Atmospheres

for rules and details of the IECEx Scheme visit www.iecex.com

Certificate No.: IECEx LCIE 15.0016X issue No.:1
Status: **Current**
Date of Issue: **2015-11-09** Page 1 of 4

Certificate history:
Issue No. 1 (2015-11-9)
Issue No. 0 (2015-5-5)

Applicant: **IMI Sensors, a PCB Piezotronics Div.**
3425 Walden Avenue
Depew, New York 14043
United States of America

Electrical Apparatus: **Vibration sensors**
Optional accessory: Types EX622 series, EX623 series, EX628 series, EXVO622 series

Type of Protection: **Ex ia, Ex nA**

Marking: **Ex ia IIC T4 Ga**
Ex nA IIC T4 Gc
IECEX LCIE 15.0016 X
(see annex for more informations)

Approved for issue on behalf of the IECEx
Certification Body:

Julien GAUTHIER

Position:

Certification Officer

Signature:
(for printed version)

Date:

2015-11-09

1. This certificate and schedule may only be reproduced in full.
2. This certificate is not transferable and remains the property of the issuing body.
3. The Status and authenticity of this certificate may be verified by visiting the [Official IECEx Website](http://www.iecex.com).

Certificate issued by:

Laboratoire Central des Industries Electriques (LCIE)
33 Avenue du General Leclerc
FR-92260 Fontenay-aux-Roses
France

Documents relative to LCIE certification activities (Certificates, QARs,
ExTRs) can be registered under the references "LCI" or "LCIE".



LCIE



IECEX Certificate of Conformity

Certificate No.: IECEx LCIE 15.0016X

Date of Issue: 2015-11-09

Issue No.: 1

Page 2 of 4

Manufacturer: **PCB Piezotronics**
3425 Walden Avenue
Depew, New York 14043
United States of America

Additional Manufacturing location
(s):

**PCB Piezotronics of
North Carolina Inc.**
10869 Hwy 903
Halifax, NC 27839
United States of America

This certificate is issued as verification that a sample(s), representative of production, was assessed and tested and found to comply with the IEC Standard list below and that the manufacturer's quality system, relating to the Ex products covered by this certificate, was assessed and found to comply with the IECEx Quality system requirements. This certificate is granted subject to the conditions as set out in IECEx Scheme Rules, IECEx 02 and Operational Documents as amended.

STANDARDS:

The electrical apparatus and any acceptable variations to it specified in the schedule of this certificate and the identified documents, was found to comply with the following standards:

IEC 60079-0 : 2011 Edition: 6.0	Explosive atmospheres - Part 0: General requirements
IEC 60079-11 : 2011 Edition: 6.0	Explosive atmospheres - Part 11: Equipment protection by intrinsic safety "i"
IEC 60079-15 : 2010 Edition: 4	Explosive atmospheres - Part 15: Equipment protection by type of protection "n"

*This Certificate **does not** indicate compliance with electrical safety and performance requirements other than those expressly included in the Standards listed above.*

TEST & ASSESSMENT REPORTS:

A sample(s) of the equipment listed has successfully met the examination and test requirements as recorded in

Test Report:
FR/LCIE/ExTR15.0017/00

FR/LCIE/ExTR15.0115/00

Quality Assessment Report:

NL/DEK/QAR14.0004/01



IECEx Certificate of Conformity

Certificate No.: IECEx LCIE 15.0016X

Date of Issue: 2015-11-09

Issue No.: 1

Page 3 of 4

Schedule

EQUIPMENT:

Equipment and systems covered by this certificate are as follows:

The model EX622, EX623 and EX628 series piezoelectric vibration sensors utilize a quartz crystal to convert a mechanical vibration measurement into an electric signal. The sensor consists of a sealed cylindrical metal case, which houses a pcb substrate board and a piezo crystal element. The circuitry is connected to a connector or an integral cable.

(See annex for more informations)

Marking : *see annex*

Electrical parameter : *see annex*

Routine test : *see annex*

CONDITIONS OF CERTIFICATION: YES as shown below:

Version "ia" : The apparatus must be only connected to a certified associated intrinsically safe equipment. This combination must be compatible regarding intrinsic safety rules (see electrical parameters).

Operating ambient temperature : - 54°C to + 121°C.

The apparatus shall be connected according to drawing n°8072 (page 1/2).

Version "nA" : The apparatus must be only connected to an equipment whose electrical parameters are compatible with the electrical parameters.

Operating ambient temperature : -54°C to +121°C.

The apparatus shall be connected according to drawing n°8072 (page 2/2).



IECEX Certificate of Conformity

Certificate No.: IECEX LCIE 15.0016X

Date of Issue: 2015-11-09

Issue No.: 1

Page 4 of 4

DETAILS OF CERTIFICATE CHANGES (for issues 1 and above):

Issue 01 :
Modification of the QAR
Addition of a manufacturing site

Annex: IECEX LCIE 15.0016 X - issue 01 - Annex 01.pdf



Annex 01 to Certificate IECEX LCIE 15.0016 X issue 01



Description of the equipment :

The model EX622,EX623,EX628 and EXVO622 series piezoelectric vibration sensors utilize a quartz crystal to convert a mechanical vibration measurement into an electric signal.

The sensor consists of a sealed cylindrical metal case, which houses a pcb substrate board and a piezo crystal element. The circuitry is connected to a connector or an integral cable.

Models are electrical identical, but mechanical different :

- EX628F0X with top 2-pin connector
- EX628F1X with integral molded cable
- EX622B0X with top 2-pin connector
- EX622B1X with integral molded cable
- EX622A0X with top 2-pin connector
- EX622A1X with integral molded cable
- EXVO622A0X with top 2-pin connector
- EXVO622A1X with integral molded cable
- EXVO622B0X with top 2-pin connector
- EXVO622B1X with integral molded cable
- EX623C0X with top 2-pin connector
- EX622C1X with integral molded cable
- EX623C1X with integral molded cable

X is a number from 0-9 that signifies changes to filtering, gain, frequency response etc. The changes pertain to values of resistors and/or capacitors and are within the limits specified in the component listing.

The sensors have stainless steel housings and quartz sensing element with capacitance value of 6pF for the piezoelectric sensing element for each of the EX628F0X and EX628F1X sensors. The sensors have stainless steel housings and ceramic sensing elements with capacitance value of 2000pF for the piezoelectric sensing element for each of the EX622B0X, EX622B1X, EXVO622B0X, EXVO622B1X, EX622A0X, EX622A1X, EXVO622A0X, EXVO622A1X and EX623C0X.

Marking :

IMI Sensors

Address : ...

Type : EX6... or EXVO6... (completed with the model)

Serial number : ...

Year of construction : ...

Ex ia IIC T4 Ga

Ex nA IIC T4 Gc

IECEX LCIE 14.0016 X

-54°C ≤ Ta ≤ +121°C

Version "ia" only :

$U_i \leq \dots V, I_i \leq \dots mA, P_i \leq \dots W,$

$C_i \leq \dots nF, L_i \leq \dots \mu H$ (completed according to the model)

Electrical parameters :

Version "ia":

Type	U_i (V)	I_i (mA)	P_i (W)	C_i (nF)	L_i (μH)
EX622A0X,EX622B0X,EX623C0X,EX628F0X	28	93	1	6,5	0
EXVO622B0X,EXVO622A0X	28	93	1	69,2	0
EX622A1X,EX622B1X,EX623C1X	28	93	1	67,5	305 ⁽¹⁾
EXVO622A1X,EXVO622B1X	28	93	1	81,4	61 ⁽²⁾
EX628F1X	28	93	1	61	305

⁽¹⁾ cable length 1000 FT

⁽²⁾ cable length 200FT

Version "nA":

$U \leq 28V, I \leq 93mA, P \leq 1W$



IECEX Certificate of Conformity

INTERNATIONAL ELECTROTECHNICAL COMMISSION IEC Certification Scheme for Explosive Atmospheres

for rules and details of the IECEX Scheme visit www.iecex.com

Certificate No.: **IECEX LCIE 15.0016X** issue No.: **0** Certificate history: _____

Status: **Current**

Date of Issue: **2015-05-05** Page 1 of 3

Applicant: **IMI Sensors**
A PCB Piezotronics Div.
3425 Walden Avenue
Depew, New York 14043
United States of America

Electrical Apparatus: **Vibration sensors types EX622 series, EX623 series, EX628 series, EXVO622 series**
Optional accessory:

Type of Protection: **Ex ia and Ex nA**

Marking: **Ex ia IIC T4 Ga**
Ex nA IIC T4 Gc
IECEX LCIE 15.0016 X
(see attachment for more informations)

Approved for issue on behalf of the IECEX
Certification Body:

Julien Gauthier

Position:

Certification Officer

Signature:
(for printed version)

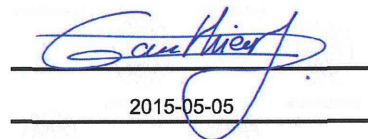

Date:

2015-05-05

1. This certificate and schedule may only be reproduced in full.
2. This certificate is not transferable and remains the property of the issuing body.
3. The Status and authenticity of this certificate may be verified by visiting the [Official IECEX Website](http://www.iecex.com).

Certificate issued by:

Laboratoire Central des Industries Electriques (LCIE)
33 Avenue du General Leclerc
FR-92260 Fontenay-aux-Roses
France

Documents relative to LCIE certification activities (Certificates, QARs, ExTRs) can be registered under the references "LCI" or "LCIE".



LCIE



IECEX Certificate of Conformity

Certificate No.: IECEx LCIE 15.0016X

Date of Issue: 2015-05-05

Issue No.: 0

Page 2 of 3

Manufacturer: **IMI Sensors**
A PCB Piezotronics Div.
3425 Walden Avenue
Depew, New York 14043
United States of America

Additional Manufacturing location
(s):

This certificate is issued as verification that a sample(s), representative of production, was assessed and tested and found to comply with the IEC Standard list below and that the manufacturer's quality system, relating to the Ex products covered by this certificate, was assessed and found to comply with the IECEx Quality system requirements. This certificate is granted subject to the conditions as set out in IECEx Scheme Rules, IECEx 02 and Operational Documents as amended.

STANDARDS:

The electrical apparatus and any acceptable variations to it specified in the schedule of this certificate and the identified documents, was found to comply with the following standards:

IEC 60079-0 : 2011 Edition: 6.0	Explosive atmospheres - Part 0: General requirements
IEC 60079-11 : 2011 Edition: 6.0	Explosive atmospheres - Part 11: Equipment protection by intrinsic safety "i"
IEC 60079-15 : 2010 Edition: 4	Explosive atmospheres - Part 15: Equipment protection by type of protection "n"

*This Certificate **does not** indicate compliance with electrical safety and performance requirements other than those expressly included in the Standards listed above.*

TEST & ASSESSMENT REPORTS:

A sample(s) of the equipment listed has successfully met the examination and test requirements as recorded in

Test Report:

[FR/LCIE/ExTR15.0017/00](#)

Quality Assessment Report:

[CA/CSA/QAR09.0018/02](#)



IECEX Certificate of Conformity

Certificate No.: IECEx LCIE 15.0016X

Date of Issue: 2015-05-05

Issue No.: 0

Page 3 of 3

Schedule

EQUIPMENT:

Equipment and systems covered by this certificate are as follows:

The model EX622, EX623 and EX628 series piezoelectric vibration sensors utilize a quartz crystal to convert a mechanical vibration measurement into an electric signal. The sensor consists of a sealed cylindrical metal case, which houses a pcb substrate board and a piezo crystal element. The circuitry is connected to a connector or an integral cable.

(See annex for more informations)

Marking : see annex

Electrical parameter : see annex

Routine test : see annex

CONDITIONS OF CERTIFICATION: YES as shown below:

Version "ia" :The apparatus must be only connected to a certified associated intrinsically safe equipment. This combination must be compatible regarding intrinsic safety rules (see electrical parameters).

Operating ambient temperature : - 54°C to + 121°C.

The apparatus shall be connected according to drawing n°8072 (page 1/2).

Version "nA" :The apparatus must be only connected to an equipment whose electrical parameters are compatible with the electrical parameters.

Operating ambient temperature : -54°C to +121°C.

The apparatus shall be connected according to drawing n°8072 (page 2/2).



Annex 01 to Certificate IECEX LCIE 15.0016 X issue 00



Description of the equipment :

The model EX622, EX623, EX628 and EXVO622 series piezoelectric vibration sensors utilize a quartz crystal to convert a mechanical vibration measurement into an electric signal.

The sensor consists of a sealed cylindrical metal case, which houses a pcb substrate board and a piezo crystal element. The circuitry is connected to a connector or an integral cable.

Models are electrical identical, but mechanical different :

- EX628FOX with top 2-pin connector
- EX628F1X with integral molded cable
- EX622B0X with top 2-pin connector
- EX622B1X with integral molded cable
- EX622A0X with top 2-pin connector
- EX622A1X with integral molded cable
- EXVO622A0X with top 2-pin connector
- EXVO622A1X with integral molded cable
- EXVO622B0X with top 2-pin connector
- EXVO622B1X with integral molded cable
- EX623C0X with top 2-pin connector
- EX623C1X with integral molded cable

X is a number from 0-9 that signifies changes to filtering, gain, frequency response etc. The changes pertain to values of resistors and/or capacitors and are within the limits specified in the component listing.

The sensors have stainless steel housings and quartz sensing element with capacitance value of 6pF for the piezoelectric sensing element for each of the EX628FOX and EX628F1X sensors. The sensors have stainless steel housings and ceramic sensing elements with capacitance value of 2000pF for the piezoelectric sensing element for each of the EX622B0X, EX622B1X, EXVO622B0X, EXVO622B1X, EX622A0X, EX622A1X, EXVO622A0X, EXVO622A1X, EX623C0X and EX623C1X.

Marking :

IMI Sensors Address :

Type : EX6... or EXVO6... (completed with the model)

Serial number : ...

Year of construction : ...

Ex ia IIC T4 Ga

Ex nA IIC T4 Gc

IECEX LCIE 15.0016 X

-54°C ≤ Ta ≤ +121°C

Version "ia" only :

Ui ≤ ... V, Ii ≤ ... mA, Pi ≤ ... W, Ci ≤ ... nF, Li ≤ ... μH (completed according to the model)

Electrical parameters :

Version "ia":

Type	Ui (V)	Ii (mA)	Pi (W)	Ci (nF)	Li (μH)
EX622A0X, EX622B0X, EX623C0X, EX628F0X	28	93	1	6,5	0
EXVO622B0X, EXVO622A0X	28	93	1	69,2	0
EX622A1X, EX622B1X, EX623C1X	28	93	1	67,5	305 (1)
EXVO622A1X, EXVO622B1X	28	93	1	81,4	61 (2)
EX628F1X	28	93	1	61	305

(1) cable length 1000 FT

(2) cable length 200FT

Version "nA":

U ≤ 28V, I ≤ 93mA, P ≤ 1W



СЕРТИФИКАТ СООТВЕТСТВИЯ

№ ЕАЭС RU C-US.AA87.B.00217/19

Серия **RU** № **0124866**



ОРГАН ПО СЕРТИФИКАЦИИ Орган по сертификации взрывозащищенного и рудничного оборудования (ОС ЦСВЭ) Общества с ограниченной ответственностью «Центр по сертификации взрывозащищенного и рудничного оборудования» (ООО «НАНИО ЦСВЭ»). Адрес места нахождения юридического лица: Россия, 140004, Московская область, Люберецкий район, город Люберцы, поселок ВУГИ, АО «Завод «ЭКОМАШ», литера В, Объект 6, этаж 3, офис 26. Адрес места осуществления деятельности в области аккредитации: Россия, 140004, Московская область, Люберецкий район, город Люберцы, поселок ВУГИ, АО «Завод «ЭКОМАШ», Литера В, Объект 6, этаж 3, офисы 26/3, 26/4, 26/5, 27/6, 30/1, 32. Аттестат № RA.RU.11AA87 от 20.07.2015 г. Телефон: +7 (495) 558-83-53, +7 (495) 558-82-44. Адрес электронной почты: ccve@ccve.ru

ЗАЯВИТЕЛЬ Общество с ограниченной ответственностью «Альфатех». Адрес места нахождения юридического лица: Россия, 125009, Москва, Малый Гнезниковский переулок, дом № 12, помещение I, комната 4. Адрес места осуществления деятельности: Россия, 127495, Москва, Долгопрудненское шоссе, дом № 3, Технопарк «Физтехпарк». ОГРН: 1167746393792. Телефон: +7 (495) 642-49-14. Адрес электронной почты: info@alphatechgroup.ru

ИЗГОТОВИТЕЛЬ PCB Piezotronics, Inc
Адрес места нахождения юридического лица и адрес места осуществления деятельности по изготовлению продукции: 3425 Walden Av., Depew, NY 14043, США

ПРОДУКЦИЯ Пьезоэлектрические преобразователи, вибропереключатели, предусилители с Ex-маркировкой согласно приложению (см. бланки №№ 0621345, 0621346, 0621347). Документы, в соответствии с которыми изготовлены изделия – см. приложение, бланк № 0621344. Серийный выпуск.

КОД ТН ВЭД ЕАЭС 9031 80 3800, 9026 20 2000, 8517 69 9000

СООТВЕТСТВУЕТ ТРЕБОВАНИЯМ
ТР ТС 012/2011 «О безопасности оборудования для работы во взрывоопасных средах».

СЕРТИФИКАТ СООТВЕТСТВИЯ ВЫДАН НА ОСНОВАНИИ
Протокола испытаний № 235.2019-Т от 11.09.2019 Испытательной лаборатории технических устройств Автономной некоммерческой организации «Национальный испытательный и научно-исследовательский институт оборудования для взрывоопасных сред» ИЛ Ex TU (аттестат № РОСС RU.0001.21MШ19 от 16.10.2015); Акта анализа состояния производства № 35-А/19 от 14.03.2019 Органа по сертификации взрывозащищенного и рудничного оборудования (ОС ЦСВЭ) Общества с ограниченной ответственностью «Центр по сертификации взрывозащищенного и рудничного оборудования» (ООО «НАНИО ЦСВЭ») (аттестат № RA.RU.11AA87 выдан 20.07.2015); Документов, представленных заявителем в качестве доказательства соответствия продукции требованиям ТР ТС 012/2011 (см. приложение, бланк № 0621344).
Схема сертификации – 1с.

ДОПОЛНИТЕЛЬНАЯ ИНФОРМАЦИЯ
Перечень стандартов, применяемых на добровольной основе для соблюдения требований ТР ТС 012/2011 (см. приложение, бланк № 0621344). Условия и срок хранения указаны в эксплуатационной документации. Назначенный срок службы – 10 лет.

СРОК ДЕЙСТВИЯ С 13.09.2019 ПО 12.09.2024
ВКЛЮЧИТЕЛЬНО

Руководитель (уполномоченное лицо) органа по сертификации

(подпись)

Залогин Александр Сергеевич

(Ф.И.О.)

Эксперт (эксперт-аудитор) (эксперты (эксперты-аудиторы))

(подпись)

М.П. Рафалович Борис Александрович

(Ф.И.О.)



ПРИЛОЖЕНИЕ

К СЕРТИФИКАТУ СООТВЕТСТВИЯ № ЕАЭС RU C-US.AA87.B.00217/19 Лист 1

Серия RU № 0621344

**I. ПЕРЕЧЕНЬ СТАНДАРТОВ, ПРИМЕНЯЕМЫХ НА ДОБРОВОЛЬНОЙ ОСНОВЕ
ДЛЯ СОБЛЮДЕНИЯ ТРЕБОВАНИЙ ТР ТС 012/2011 «О БЕЗОПАСНОСТИ ОБОРУДОВАНИЯ
ДЛЯ РАБОТЫ ВО ВЗРЫВООПАСНЫХ СРЕДАХ»**

Обозначение стандартов	Наименование стандартов
ГОСТ 31610.0-2014 (IEC 60079-0:2011)	Взрывоопасные среды. Часть 0. Оборудование. Общие требования
ГОСТ IEC 60079-1-2011	Взрывоопасные среды. Часть 1. Оборудование с видом взрывозащиты «взрывонепроницаемые оболочки «d»
ГОСТ 31610.11-2014 (IEC 60079-11:2011)	Взрывоопасные среды. Часть 11. Оборудование с видом взрывозащиты «искробезопасная электрическая цепь «i»
ГОСТ 31610.15-2012/МЭК 60079-15:2005	Электрооборудование для взрывоопасных газовых сред. Часть 15. Конструкция, испытания и маркировка электрооборудования с видом защиты «п»

**II. ДОКУМЕНТЫ, ПРЕДСТАВЛЕННЫЕ ЗАЯВИТЕЛЕМ В КАЧЕСТВЕ ДОКАЗАТЕЛЬСТВА
СООТВЕТСТВИЯ ПРОДУКЦИИ ТРЕБОВАНИЯМ ТР ТС 012/2011**

Руководства по эксплуатации: № 750119 от 23.01.19, № 830119 от 23.01.19, № 940219 от 07.02.19, № 630119 от 22.01.19, № 610119 от 22.01.19, № 910219 от 07.02.19, № 950219 от 08.02.19, № 970219 от 08.02.19.
Технические файлы: № 54202 от 02.02.2017, № 54204 от 02.02.2017, № 22438 С от 19.07.2012, № 62501 от 06.10.2016, № 33699 от 16.06.2016, № 56178 от 01.07.2016, № 70893 от 24.07.2019, № 54707 от 10.08.2016, № 48813 от 06.01.2011
Чертежи: № 47912 от 31.03.2017, № 49038 от 31.03.2017.
Перечень стандартов см. п. I.

III. ДОКУМЕНТЫ, В СООТВЕТСТВИИ С КОТОРЫМИ ИЗГОТОВЛЕНА ПРОДУКЦИЯ

Технические файлы: № 54202 от 02.02.2017, № 54204 от 02.02.2017, № 22438 С от 19.07.2012, № 62501 от 06.10.2016, № 33699 от 16.06.2016, № 56178 от 01.07.2016, № 70893 от 24.07.2019, № 54707 от 10.08.2016, № 48813 от 06.01.2011
Чертежи: № 47912 от 31.03.2017, № 49038 от 31.03.2017

Руководитель (уполномоченное
лицо) органа по сертификации

(подпись)

Эксперт (эксперт-аудитор)
(эксперты (эксперты-аудиторы))

(подпись)



Залогин Александр Сергеевич
(Ф.И.О.)

М.П.

Рафалович Борис Александрович
(Ф.И.О.)

ПРИЛОЖЕНИЕ

К СЕРТИФИКАТУ СООТВЕТСТВИЯ № ЕАЭС RU C-US.AA87.B.00217/19 Лист 2

Серия RU № 0621345

1. НАЗНАЧЕНИЕ И ОБЛАСТЬ ПРИМЕНЕНИЯ

Пьезоэлектрические преобразователи (далее – преобразователи) предназначены для контроля параметров вибрации, динамического давления и преобразования их в электрический сигнал.

Вибропереключатели предназначены для контроля уровня вибрации и защиты оборудования от повышенной вибрации.

Предусилители предназначены для преобразования зарядового сигнала в вольтовый.

Область применения - взрывоопасные зоны помещений и наружных установок согласно Ex-маркировке, ГОСТ IEC 60079-14-2013, регламентирующих применение во взрывоопасных средах.

2. СТРУКТУРНОЕ ОБОЗНАЧЕНИЕ

2.1. Преобразователи 176ХУУ/МZZZ-АА

X = от А до Z ревизия продукта, не влияющая на взрывозащиту

УУ = от 01 до 99 для индикации вариантов монтажа, диафрагмы, кабелей или разъемов

M = опционально для указания метрической длины кабеля

ZZZ = от 001 до 999 опционально для указания длины кабеля в футах: (не более 200 футов) или метрах: (не более 61 м)

AA = от 01 до 99 опционально для указания дробной длины кабеля в дюймах или сантиметрах, не влияющей на взрывозащиту

2.2. Преобразователи 351abcd

a – ревизия продукта, может быть: А,В,С,Д,Е,F,G,H,I,J,K,L или M, не влияющая на взрывозащиту

b – первая цифра вариации продукта, может быть: 0,1,2,3,4,5,6,7,8 или 9, не влияющая на взрывозащиту

c – вторая цифра вариации продукта, может быть: 0,1,2,3,4,5,6,7,8 или 9, не влияющая на взрывозащиту

d – третья цифра вариации продукта, может быть: 0,1,2,3,4,5,6,7,8,9 или отсутствует, не влияющая на взрывозащиту

2.3 Преобразователи EX(TO)(M)602yzzz/aaa, EX(TO)(M)603yzzz/aaa, EX(TO)(M)606yzzz/aaa, EX(TO)(M)607yzzz/aaa, EX(TO)(M)608yzzz/aaa, EX(M)637XYYYZ, (M)638XYYYZ

XX = TO (с температурным выходом), M (с метрической резьбой),

y = одна буква от А до Z, не влияющая на взрывозащиту

zzz = две или три цифры от 00 до 999, не влияющие на взрывозащиту

aaa = длина кабеля и/или тип разъема

2.4 Предусилители EX682XYYY

X – ревизия продукта (А,В ... М), не влияющая на взрывозащиту

YYY: параметры фильтрации, усиления, частотная характеристика, ... (от 1 до 999), не влияющие на взрывозащиту

2.5 Преобразователи EX(RV)(TO)(M)64хухх, EX(RV)(TO)(M)649ухх, EX (RV)(TO) (M)686ухх

XX = M (с метрической резьбой), TO (с температурным выходом), RV (с доп. вольтовым выходом).

Буквы х являются переменными цифрами (значения от 0 до 9), не влияющими на взрывозащиту

y = одна буква от А до Z, не влияющая на взрывозащиту

2.6 Преобразователи EX (XX) 622yzzz / aaa, EX (XX) 623yzzz / aaa, EX (XX) 625yzzz / aaa, EX (XX) 628yzzz / aaa

XX = HT (Высокотемпературная версия), M (с метрической резьбой), TO (с температурным выходом), VO (с выходом по скорости).

y = одна буква от А до Z, не влияющая на взрывозащиту

zzz = две или три цифры от 00 до 999, не влияющие на взрывозащиту

aaa = длина кабеля и/или тип разъема

2.7 Вибропереключатели 685ухх

Буквы х являются переменными цифрами (значения от 0 до 9), не влияющими на взрывозащиту

y = одна буква от А до Z, не влияющая на взрывозащиту

Руководитель (уполномоченное лицо) органа по сертификации

(подпись)

Залогин Александр Сергеевич (Ф.И.О.)

Эксперт (эксперт-аудитор) (эксперты (эксперты-аудиторы))

(подпись)

Рафалович Борис Александрович (Ф.И.О.)

ПРИЛОЖЕНИЕ

К СЕРТИФИКАТУ СООТВЕТСТВИЯ № ЕАЭС RU C-US.AA87.B.00217/19 Лист 3

Серия **RU** № **0621346**

3. ОСНОВНЫЕ ТЕХНИЧЕСКИЕ ДАННЫЕ

3.1. Ех-маркировка: преобразователей 176XYU/MZZ-AA	0Ex ia IIC T660°C...T6 Ga X
преобразователей 351abcd	0Ex ia IIC T4 Ga X
вибропереключателей 685yxx	1Ex d IIB+H ₂ T4 Gb
преобразователей EX(TO)(M)602yzzz1aaa, EX(TO)(M)603yzzz/aaa, EX(TO)(M)606yzzz/aaa, EX(TO)(M)607yzzz/aaa, EX(TO)(M)608yzzz/aaa	2Ex nA IIC T4 Gc X или 0Ex ia IIC T4 Ga X
преобразователей EX(M)637XYUZY, (M)638XYUZY	0Ex ia IIC T4 Ga X или 2Ex nA IIC T4 Gc X
предусилителей EX682XYUZY	0Ex ia IIC T4 Ga X или 2Ex nA IIC T4 Gc X
EX(RV)(TO)(M)64хyxx, EX(RV)(TO)(M)649yxx, EX (RV)(TO) (M)686yxx	1Ex d IIC T4 Gb X или 1Ex d IIC T3 Gb X
преобразователей EX (XX) 622yzzz / aaa, EX (XX) 623yzzz / aaa, EX (XX) 625yzzz / aaa , EX (XX) 628yzzz / aaa	2Ex nA IIC T4 Gc X
3.2. Диапазон температур окружающей среды, °С, преобразователей 176XYU/MZZ-AA	от -70 до 650
преобразователей 351abcd	от -196 до 121
вибропереключателей 685yxx	от -25 до 60
преобразователей EX(TO)(M)602yzzz1aaa, EX(TO)(M)603yzzz/aaa, EX(TO)(M)606yzzz/aaa, EX(TO)(M)607yzzz/aaa, EX(TO)(M)608yzzz/aaa	от -54 до 121
преобразователей EX(M)637XYUZY, (M)638XYUZY	от -196 до 121
предусилителей EX682XYUZY	от -40 до 85
преобразователей EX(RV)(TO)(M)64хyxx, EX(RV)(TO)(M)649yxx, EX (RV)(TO) (M)686yxx	от -20 до 80
преобразователей EX (XX) 622yzzz / aaa, EX (XX) 623yzzz / aaa, EX (XX) 625yzzz / aaa , EX (XX) 628yzzz / aaa	от -54 до 121

3.3. Входные искробезопасные электрические параметры преобразователей, предусилителей:

Модель	U _i , В	I _i , мА	P _i , Вт	C _i , нФ	L _i , мГн
преобразователей 176XYU/MZZ-AA	30	300	1	5	0,5
преобразователей 351abcd	28	200	1,2	61	305 мкГн
преобразователей EX(TO)(M)602yzzz1aaa, EX(TO)(M)603yzzz/aaa, EX(TO)(M)606yzzz/aaa, EX(TO)(M)607yzzz/aaa, EX(TO)(M)608yzzz/aaa	28	200	1	16,2 или 77,2 (с кабелем)	пренебрежимо мала или 305 мкГн (с учетом кабеля 305м)
преобразователей EX(M)637XYUZY, (M)638XYUZY	28	93	0,65	6,5	пренебрежимо мала
предусилителей EX682XYUZY	28	100	0,7	пренебрежимо мала	пренебрежимо мала

Руководитель (уполномоченное
лицо) органа по сертификации

(подпись)

Эксперт (эксперт-аудитор)
(эксперты (эксперты-аудиторы))

(подпись)

Залогин Александр Сергеевич

(Ф.И.О.)

М.П. Рафалович Борис Александрович

(Ф.И.О.)

ПРИЛОЖЕНИЕ

К СЕРТИФИКАТУ СООТВЕТСТВИЯ № ЕАЭС RU C-US.AA87.B.00217/19 Лист 4

Серия **RU** № **0621347**

3.4. Электрические параметры:

3.4.1 вибропереключателей 685ухх

Напряжение питания, В 85-245 (AC), 24 (DC)
 Максимальный ток, mA 150

3.4.2 преобразователей EX(TO)(M)602yzzz/aaa, EX(TO)(M)603yzzz/aaa, EX(TO)(M)606yzzz/aaa, EX(TO)(M)607yzzz/aaa, EX(TO)(M)608yzzz/aaa, EX (XX) 622yzzz / aaa, EX (XX) 623yzzz / aaa, EX (XX) 625yzzz / aaa, EX (XX) 628yzzz / aaa

с Ex-маркировкой 2Ex nA IIC T4 Gc X:

Напряжение питания, В 28
 Максимальный ток, mA 200
 Мощность, Вт 1

3.4.3 преобразователей EX(M)637XYYYZ, (M)638XYYYZ

Напряжение питания, В 18 – 28
 Максимальный ток, mA 1,6 – 20
 Мощность, Вт 0,5

3.4.4 Предусилителей EX682XYYY

Напряжение питания, В 22 – 28
 Максимальный ток, mA 3,1 – 4,1
 Мощность, Вт 0,1

3.4.5 преобразователей EX(RV)(TO)(M)64уххх, EX(RV)(TO)(M)649ухх, EX (RV)(TO) (M)686ухх

Напряжение питания, В 18 – 30
 Максимальный ток, mA 1,6 – 20
 Мощность, Вт 0,5

4. ОПИСАНИЕ КОНСТРУКЦИИ И СРЕДСТВ ОБЕСПЕЧЕНИЯ ВЗРЫВОЗАЩИЩЕННОСТИ

Преобразователи состоят из герметичного цилиндрического металлического корпуса, в котором размещается печатная плата и пьезокристаллический элемент. Сборка подключается к разъему или встроенному кабелю. На наружной поверхности корпуса преобразователя нанесена маркировка.

Вибропереключатели серии 685ухх выполнены в металлическом корпусе, внутри которого размещена электронная плата. На наружной поверхности корпуса нанесена маркировка.

Предусилители серии EX682XYYY выполнены в прямоугольном пластиковом корпусе с креплением на DIN рейку. Внутри корпуса размещена электронная плата. На корпусе размещен съемный клеммный блок. На наружной поверхности корпуса нанесена маркировка.

Подробное описание конструкции приведено в Руководствах по эксплуатации №750119 от 23.01.19, №830119 от 23.01.19, №940219 от 07.02.19, №630119 от 22.01.19, №610119 от 22.01.19, №910219 от 07.02.19, №950219 от 08.02.19, №970219 от 08.02.19

Взрывозащищенность преобразователей, вибропереключателей и предусилителей обеспечивается выполнением требований: ГОСТ 31610.15-2012/МЭК 60079-15:2005, ГОСТ 31610.0-2014 (IEC 60079-0:2011), ГОСТ IEC 60079-1-2011, ГОСТ 31610.11-2014 (IEC 60079-11:2011), в соответствии с Ex-маркировкой.

5. МАРКИРОВКА

Маркировка, наносимая на преобразователи, вибропереключатели и предусилители, включает следующие данные:

- товарный знак или наименование предприятия-изготовителя;
- серийный номер или номер партии;
- диапазон значений температур окружающей среды при эксплуатации;
- Ex-маркировку;
- специальный знак взрывобезопасности;
- наименование центра по сертификации и номер сертификата;
- предупредительные надписи;
- искробезопасные параметры

и другие данные, которые изготовитель должен отразить в маркировке, в соответствии с требованиями нормативной и технической документации.

6. СПЕЦИАЛЬНЫЕ УСЛОВИЯ ПРИМЕНЕНИЯ

5.1 Знак X, стоящий после Ex-маркировки, означает, что при эксплуатации преобразователей, вибропереключателей, предусилителей необходимо соблюдать следующие специальные условия:

- преобразователи, вибропереключатели, предусилители должны быть подключены к сертифицированному на соответствие требованиям ТР ТС 012/2011 источнику питания с соответствующей областью применения.

5.2 Свободные концы постоянно подсоединенного кабеля должны подключаться в сертифицированной на соответствие требованиям ТР ТС 012/2011 соединительной коробке или вне взрывоопасной зоны.

Специальные условия применения, обозначенные знаком X, отражены в сопроводительной документации, подлежащей обязательной поставке в комплекте с каждым изделием.

Внесение изменений в конструкцию изделий возможно только по согласованию с ОС ЦСВЭ в соответствии с требованиями ТР ТС 012/2011.

Руководитель (уполномоченное
лицо) органа по сертификации

Эксперт (эксперт-аудитор)
(эксперты (эксперты-аудиторы))

(подпись)

(подпись)

Залогин Александр Сергеевич

(ф.и.о.)

М.П. Рафалович Борис Александрович

(ф.и.о.)